

# GreenSonar

BOF

co-chairs's:  
(?) Cees de Laat & (?) Inder Monga

GGF35, Delft, June 2012

# OGF IPR Policies Apply



- “I acknowledge that participation in this meeting is subject to the OGF Intellectual Property Policy.”
- Intellectual Property Notices Note Well: All statements related to the activities of the OGF and addressed to the OGF are subject to all provisions of Appendix B of GFD-C.1, which grants to the OGF and its participants certain licenses and rights in such statements. Such statements include verbal statements in OGF meetings, as well as written and electronic communications made at any time or place, which are addressed to:
  - the OGF plenary session,
  - any OGF working group or portion thereof,
  - the OGF Board of Directors, the GFSG, or any member thereof on behalf of the OGF,
  - the ADCOM, or any member thereof on behalf of the ADCOM,
  - any OGF mailing list, including any group list, or any other list functioning under OGF auspices,
  - the OGF Editor or the document authoring and review process
- Statements made outside of a OGF meeting, mailing list or other function, that are clearly not intended to be input to an OGF activity, group or function, are not subject to these provisions.
- Excerpt from Appendix B of GFD-C.1: “Where the OGF knows of rights, or claimed rights, the OGF secretariat shall attempt to obtain from the claimant of such rights, a written assurance that upon approval by the GFSG of the relevant OGF document(s), any party will be able to obtain the right to implement, use and distribute the technology or works when implementing, using or distributing technology based upon the specific specification(s) under openly specified, reasonable, non-discriminatory terms. The working group or research group proposing the use of the technology with respect to which the proprietary rights are claimed may assist the OGF secretariat in this effort. The results of this procedure shall not affect advancement of document, except that the GFSG may defer approval where a delay may facilitate the obtaining of such assurances. The results will, however, be recorded by the OGF Secretariat, and made available. The GFSG may also direct that a summary of the results be included in any GFD published containing the specification.”
- OGF Intellectual Property Policies are adapted from the IETF Intellectual Property Policies that support the Internet Standards Process.

# Agenda

Monday Mar. 18th, 9h30 – 10h30

- Agenda Bashing
- Proposal
- Leadership
- Any Other Subject
- Adjourn



# LinkedIn for Infrastructure



- From semantic Web / Resource Description Framework.
- The RDF uses XML as an interchange syntax.
- Data is described by triplets (Friend of a Friend):

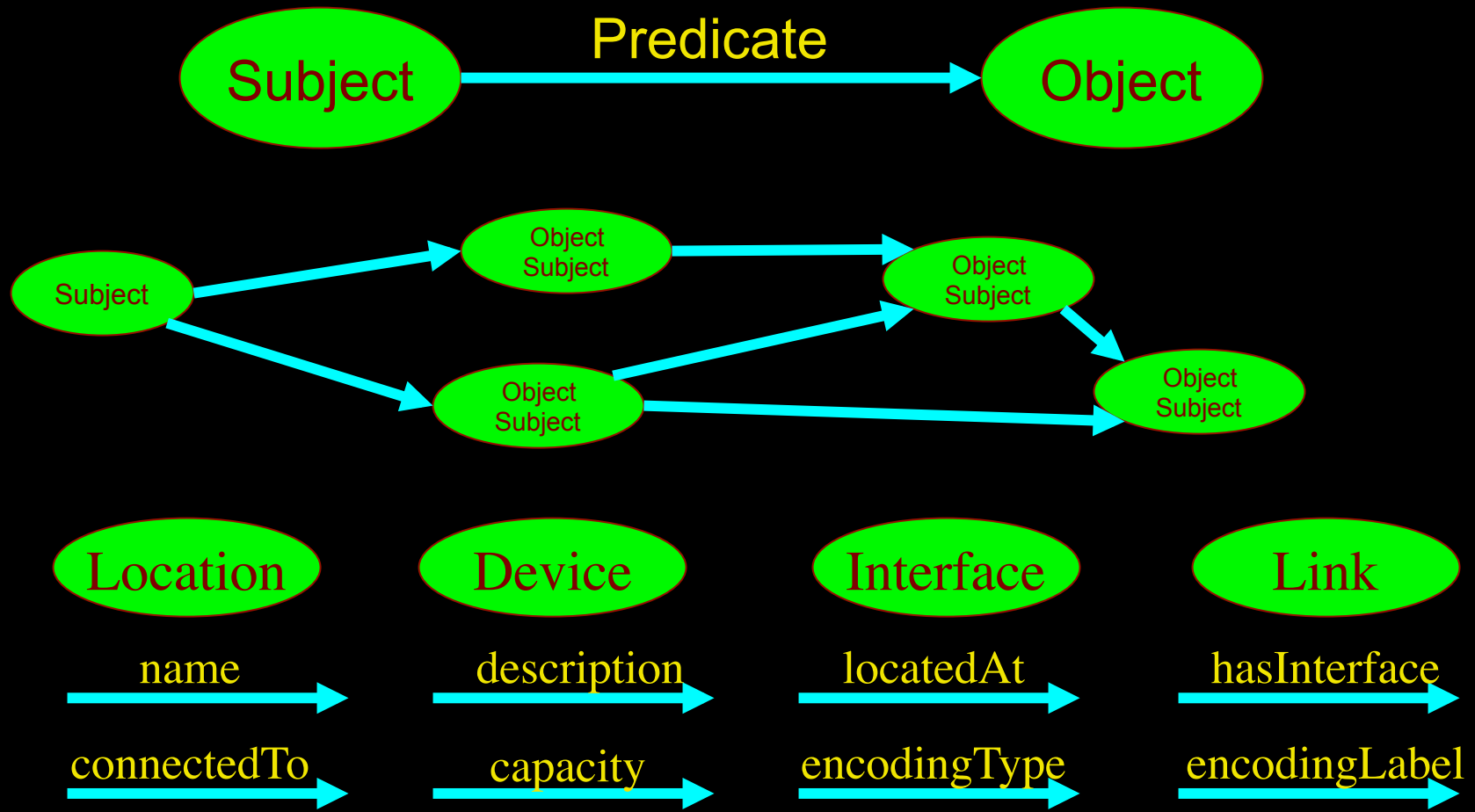

# Multi-layer descriptions in NDL

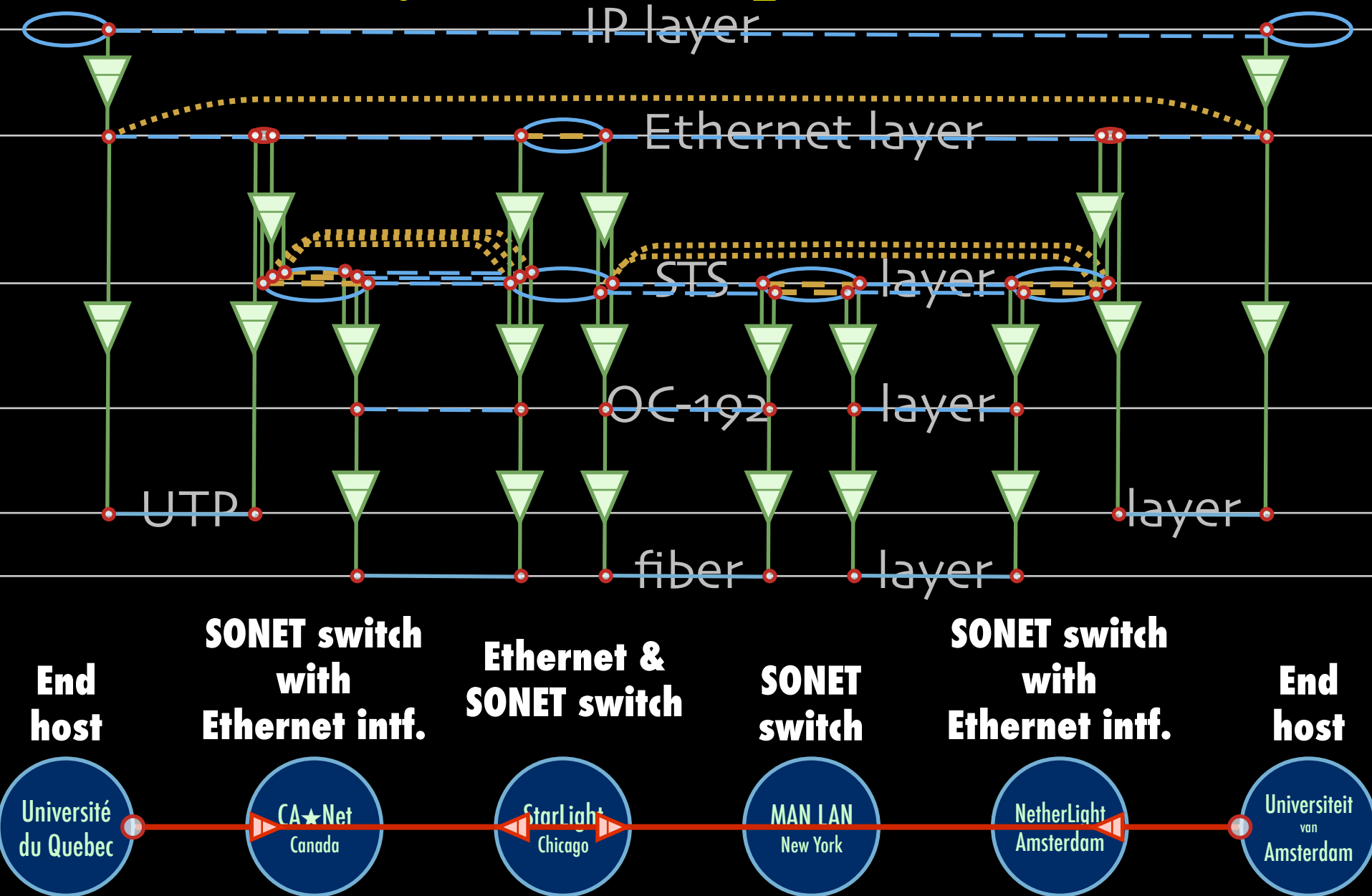

# Multi-layer Network PathFinding

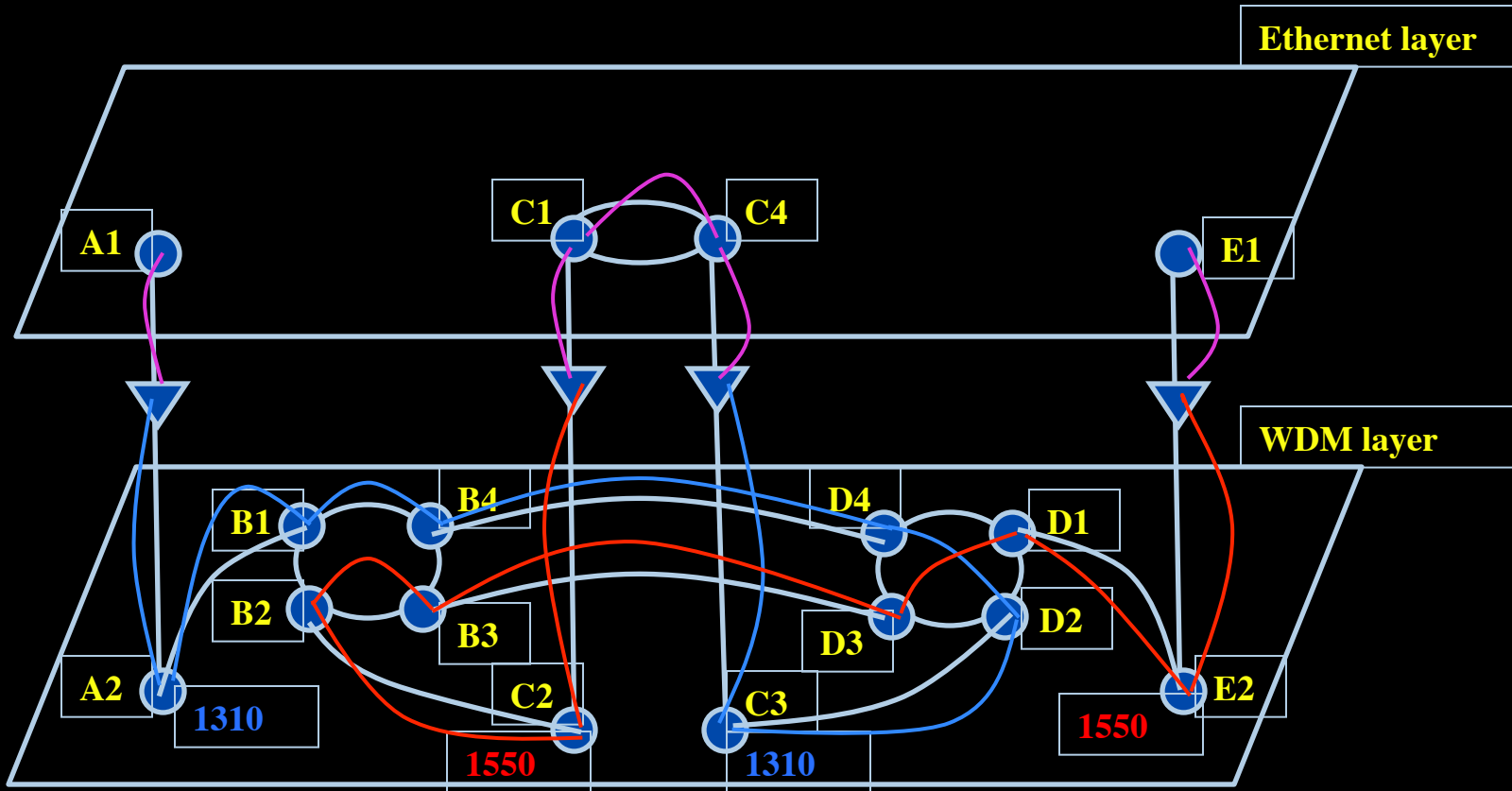

Path between interfaces A1 and E1:

A1-A2-B1-B4-D4-D2-C3-C4-C1-C2-B2-B3-D3-D1-E2-E1

Scaling: Combinatorial problem

# Information Modeling

Define a common information model for **infrastructures** and **services**.  
Base it on Semantic Web.

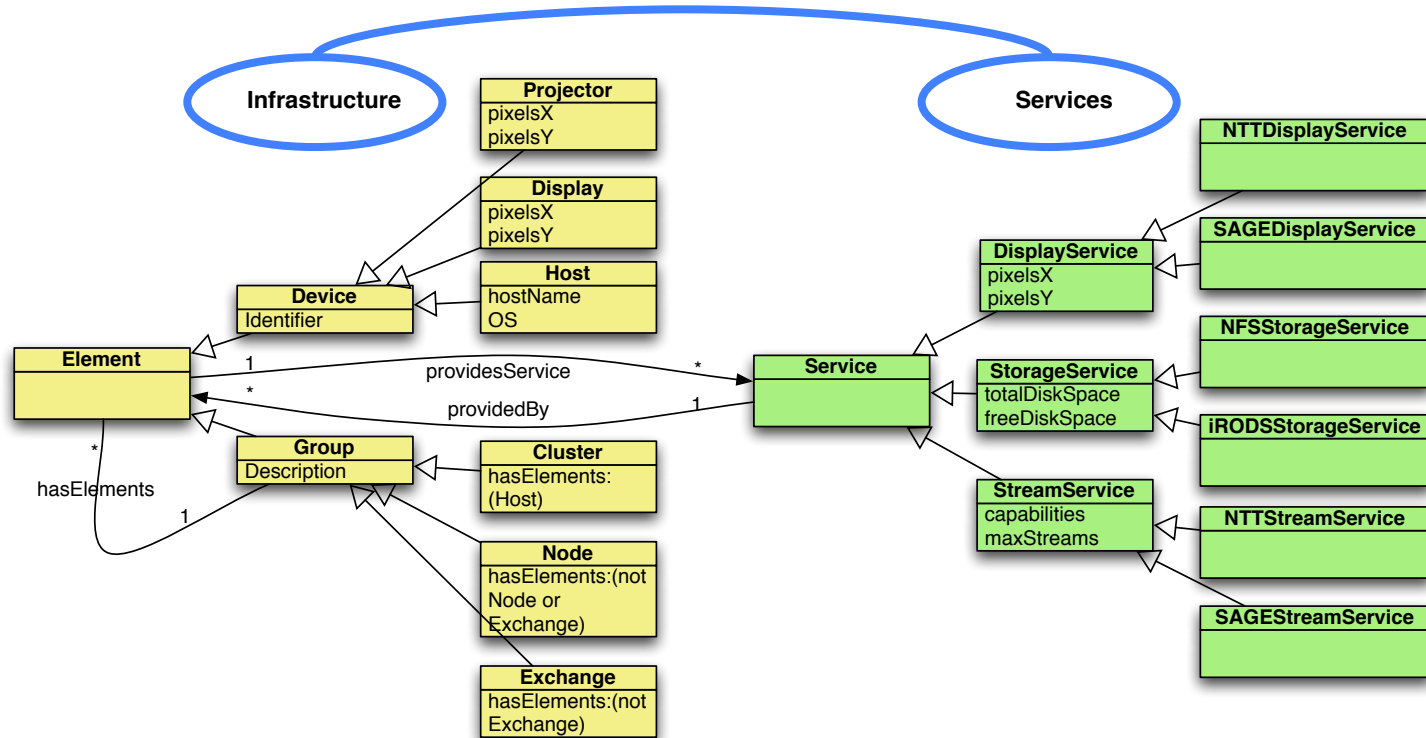



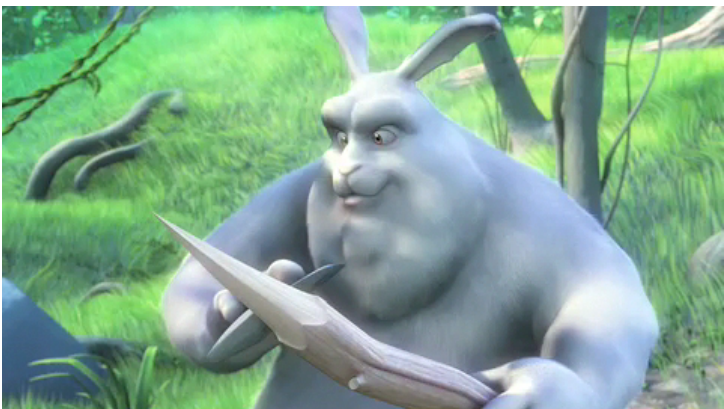

I want to



“Show Big Bug Bunny in 4K on my Tiled Display using green Infrastructure”

- Big Bugs Bunny can be on multiple servers on the Internet.
- Movie may need processing / recoding to get to 4K for Tiled Display.
- Needs deterministic Green infrastructure for Quality of Experience.
- Consumer / Scientist does not want to know the underlying details.  
➔ His refrigerator also just works.

# RDF describing Infrastructure “I want”

Application: find video containing x,  
then trans-code to it view on Tiled Display

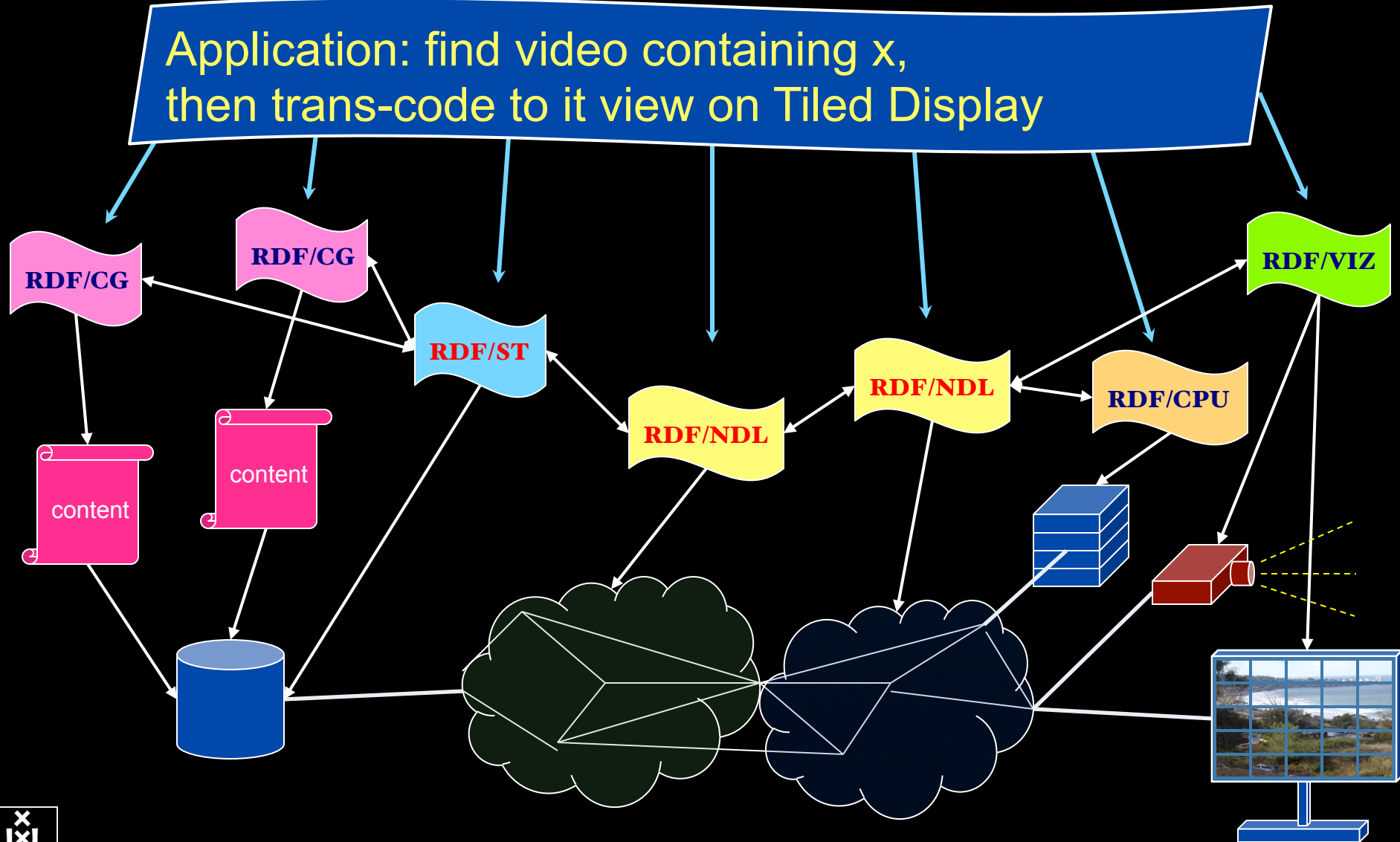

# The Ten Problems with the Internet

- 1. Energy Efficient Communication**
2. Separation of Identity and Address
3. Location Awareness
- 4. Explicit Support for Client-Server Traffic and Distributed Services**
5. Person-to-Person Communication
6. Security
- 7. Control, Management, and Data Plane separation**
- 8. Isolation**
9. Symmetric/Asymmetric Protocols
- 10. Quality of Service**

*Nice to have:*

- Global Routing with Local Control of Naming and Addressing
- **Real Time Services**
- **Cross-Layer Communication**
- Multicast
- Receiver Control
- Support for Data Aggregation and Transformation
- **Support for Streaming Data**
- **Virtualization**

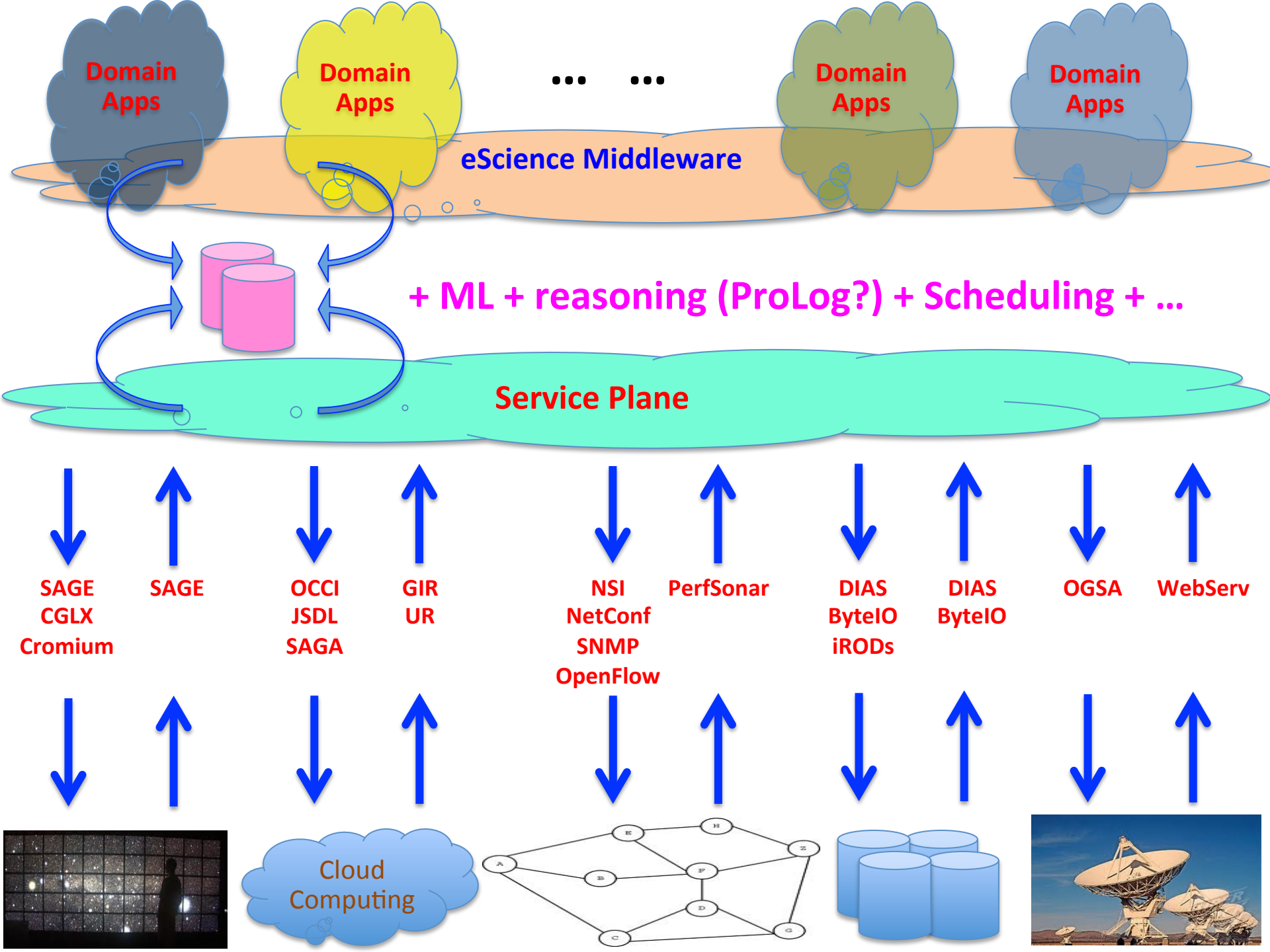

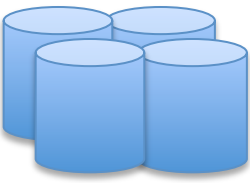
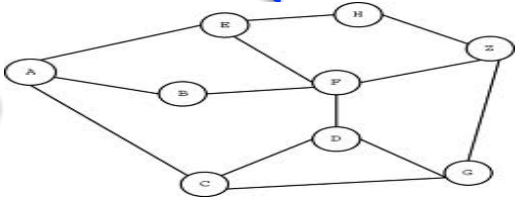
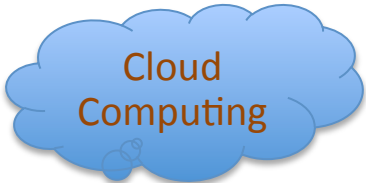
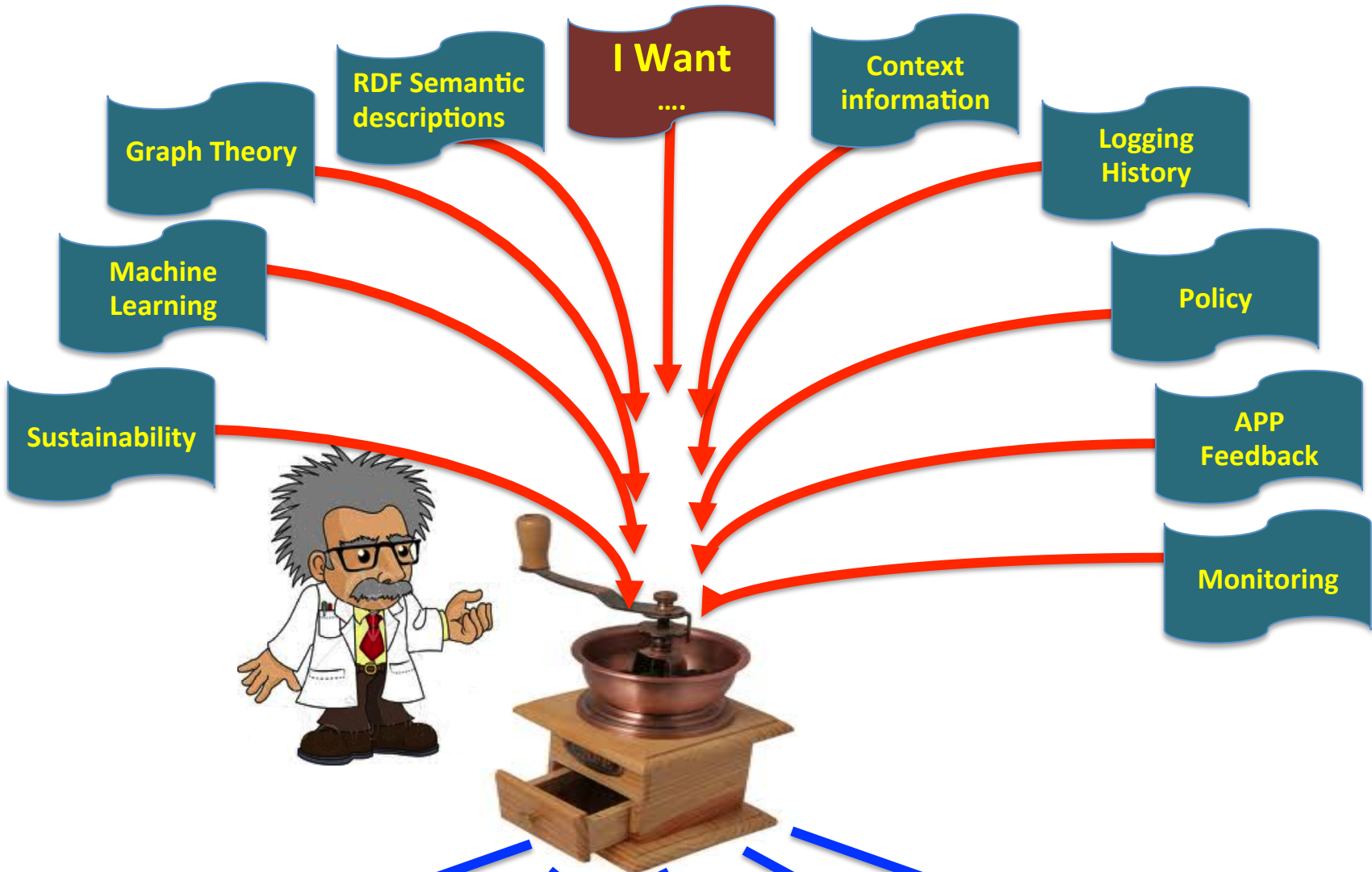

# ECO-Scheduling



# Optical Exchange as Black Box

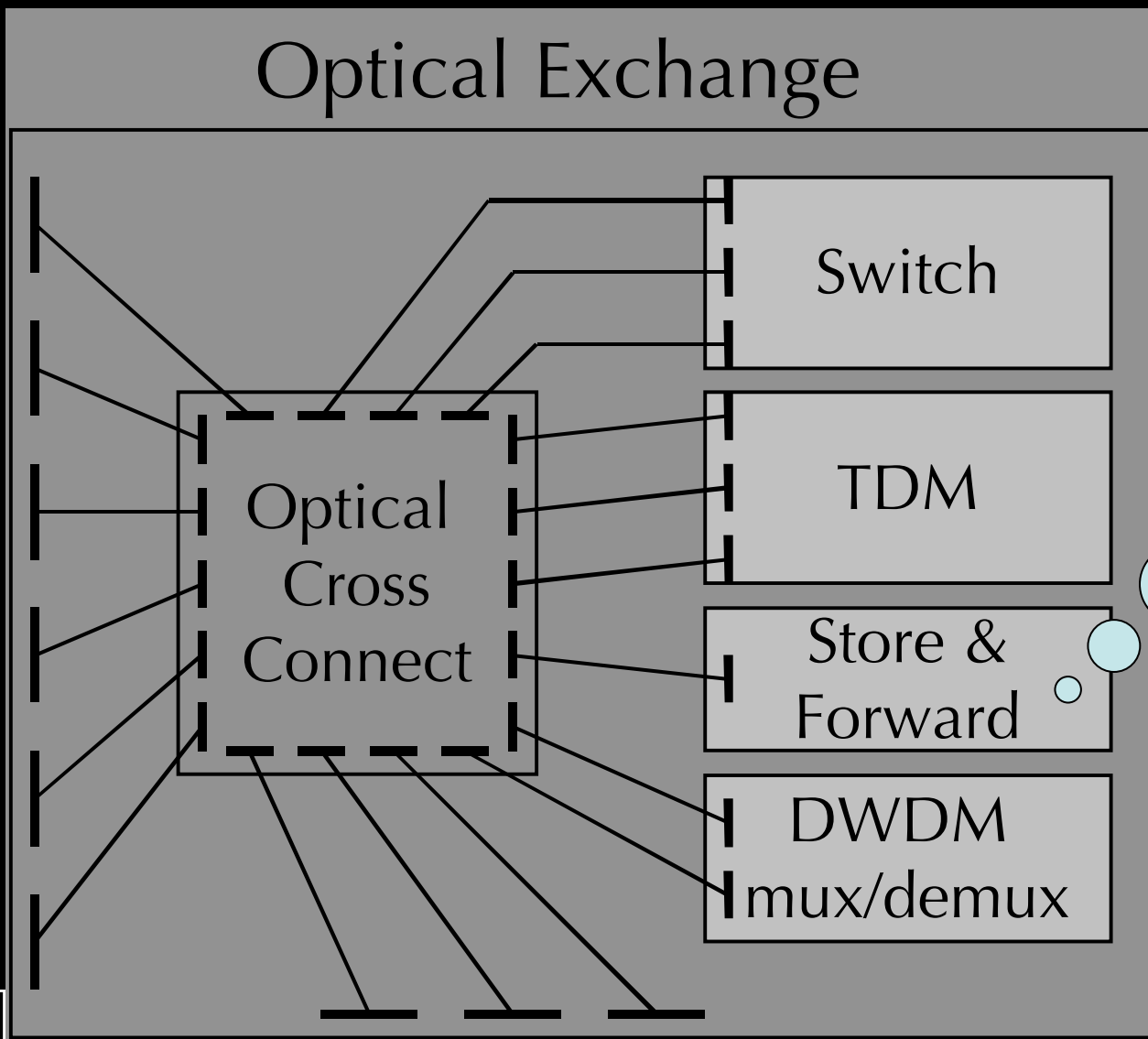

TeraByte  
Email  
Service



# Links

- <http://ext.delaat.net/>
- <http://ext.delaat.net/smartgreen/index.html>
- [http://ext.delaat.net/news/2012-03-23/  
index.html](http://ext.delaat.net/news/2012-03-23/index.html)



# Full Copyright Notice

Copyright (C) Open Grid Forum (**applicable years**). All Rights Reserved.

This document and translations of it may be copied and furnished to others, and derivative works that comment on or otherwise explain it or assist in its implementation may be prepared, copied, published and distributed, in whole or in part, without restriction of any kind, provided that the above copyright notice and this paragraph are included on all such copies and derivative works.

The limited permissions granted above are perpetual and will not be revoked by the OGF or its successors or assignees.