

Internet

From a network experiment that never ended (Vint Cerf)

- 1974: for the first time the word **internet** (*RFC 675 - Specification of Internet Transmission Control Program*) [note -> Open process!]
- 1981: the **TCP/IP** standard was ready to be adopted (*RFC 791,792,793*)

To a network for society

- 1989: WWW was born

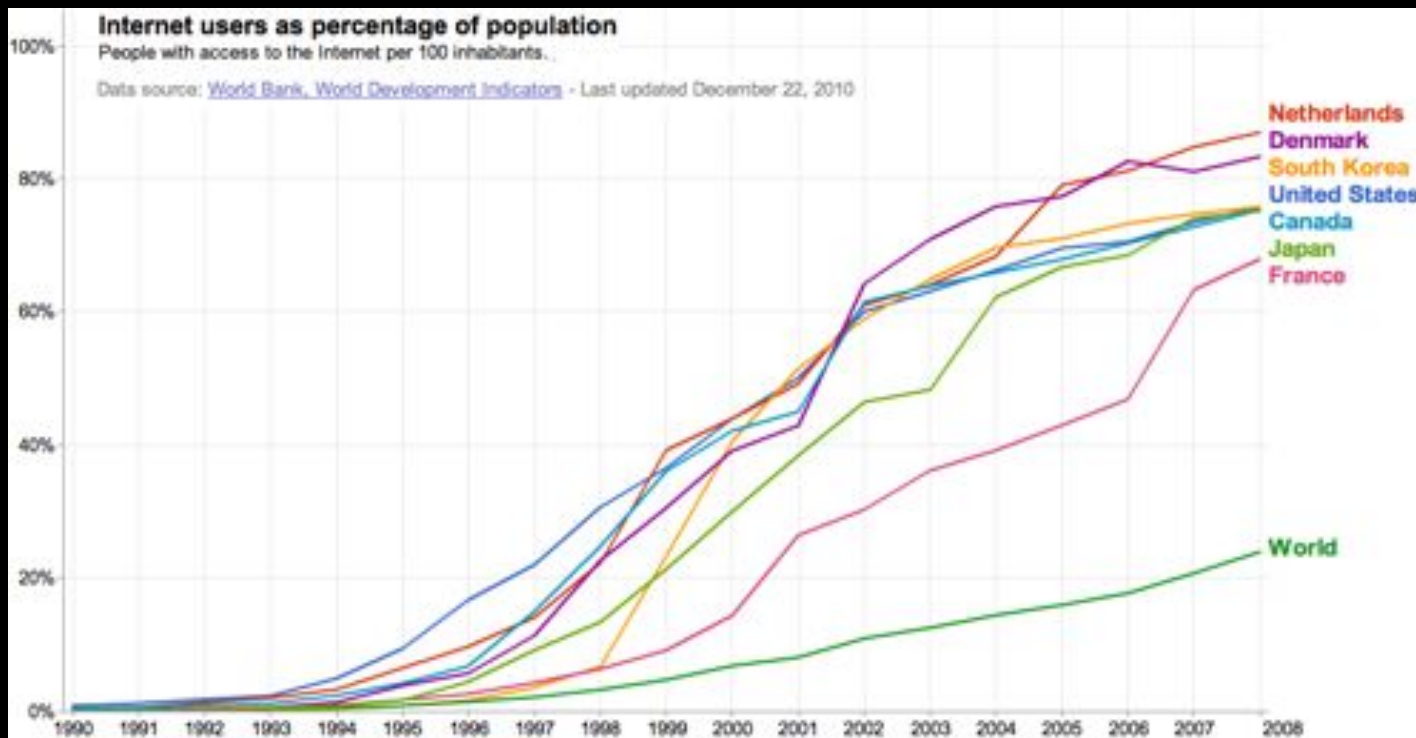

June 8th @ UvA

- Jan 2011 → IANA IPv4 address space depleted! →

Ipv6day.nl

Internet is a Billion - Business!

Google	197
Amazon	83
Facebook	50
BAIDU	37
eBay	36
Yahoo	22
PriceLine	21
SalesForce	18
F5 Networks	11
CheckPoint	9
NetFlix	9
Expedia	7



e.g.: Exxon Mobil 368
Apple Inc. 333



1 miljard in 100\$ biljetten

... more data!

Internet developments

Google

Speed
Volume

DATA

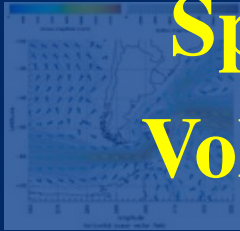

Deterministic

Real-time



twitter



Scalable

Secure

Linked in



myspace

SchoolBANK

Hyves

flickr

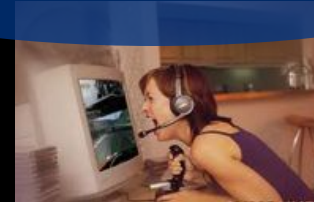

... more users!







GPU cards are disruptive!

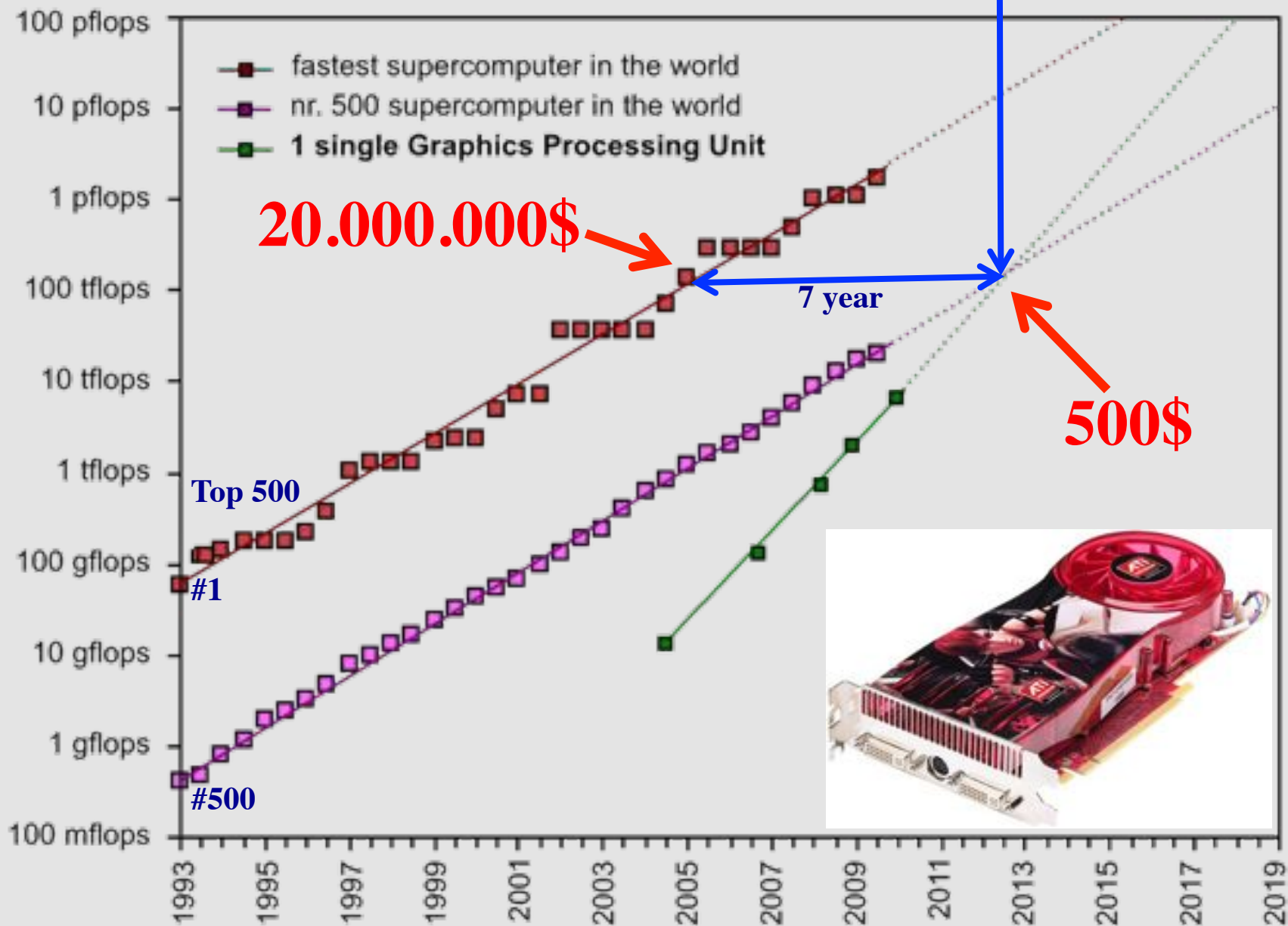

Data storage: doubling every 1.5 year!

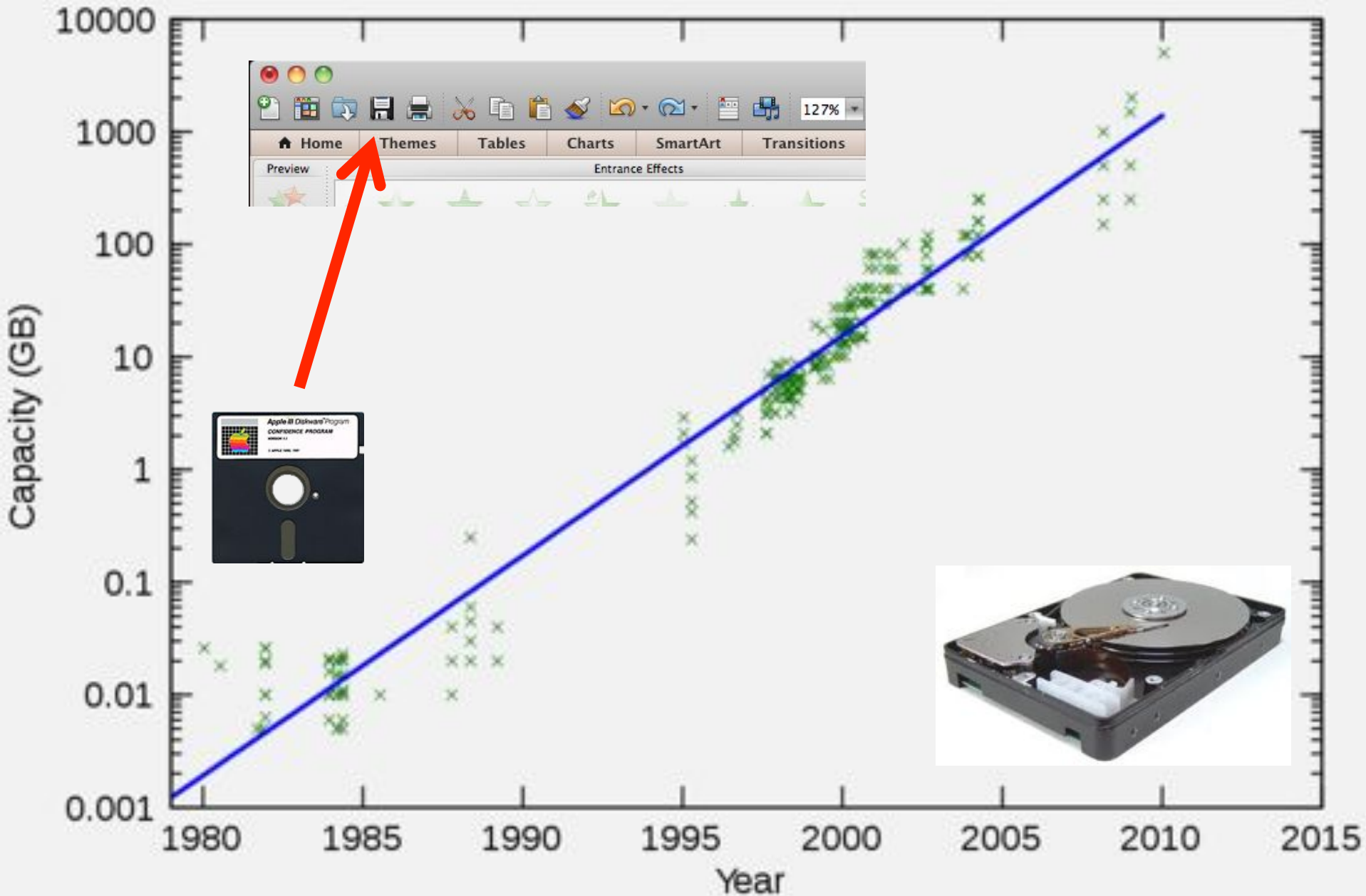

Multiple colors / Fiber

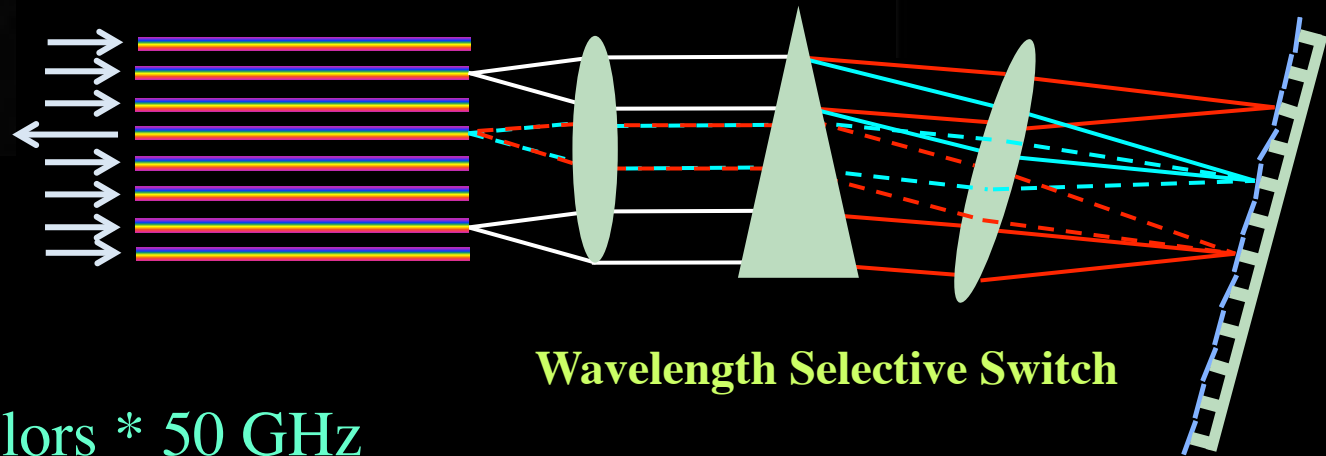
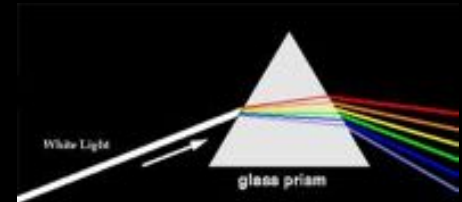
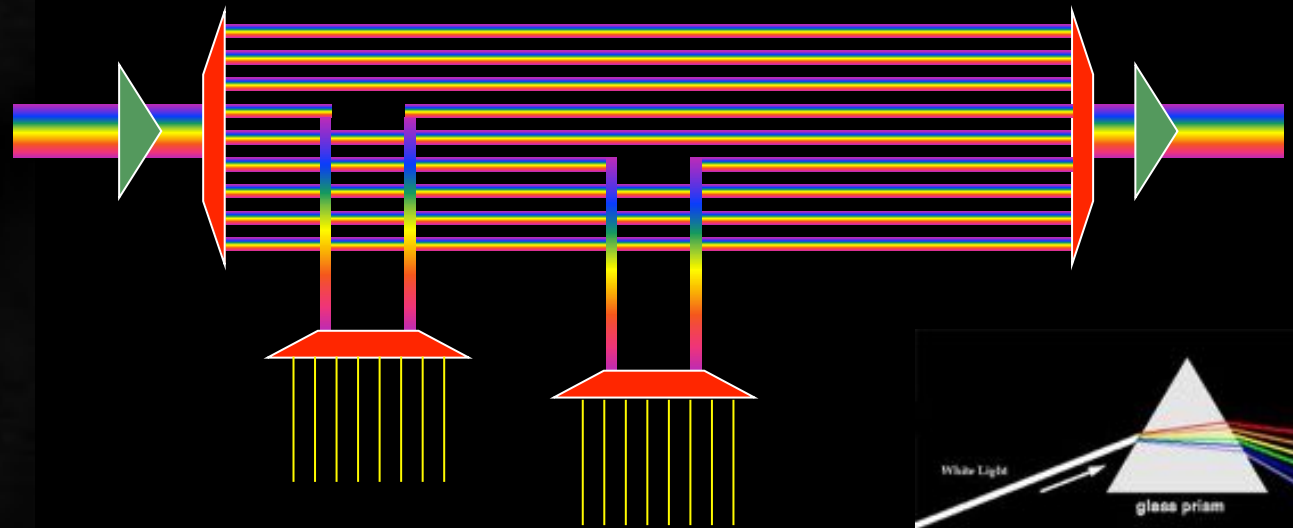

Per fiber: ~ 80-100 colors * 50 GHz
Per color: 10 – 40 – 100 Gbit/s
BW * Distance ~ $2 \cdot 10^{17}$ bm/s

New: Hollow Fiber!
➔ less RTT!

Wireless Networks



Digital technology reviews

Tech XO provided latest Digital Technology reviews like digital camera,digital lens reviews,digital

HOME

CONTACT US

PRIVACY POLICY

You Are Here : Digital Technology Reviews » Network Devices » Next Generation
Throughput With

SEP
06

Next Generation Wireless LAN Technology 802.11ac 1 Gbps throughput with

Published By Admin under Network Devices Tags: 1gbps throughput, 1gbps
wireless, 1gbps wireless lans, generation, new generation, technologies,
technology, throughput, wireless, wireless lan

WiFi is one of the most
preferred communication

protocol LAN due to the easy comparison and convenience in the digital home. While
consumer PC products has just started to migrate to a much higher bandwidth of 802.11n
wireless LAN now working on next-generation standard definition is already in progress.

Wireless Networks



COPYRIGHT: WORTEN HILSMANN

protocol LAN due to the easy comparison and convenience in the digital home. While consumer PC products has just started to migrate to a much higher bandwidth of 802.11n wireless LAN now working on next-generation standard definition is already in progress.

SNE @ UvA

Speed
Volume

Deterministic
Real-time

Scalable
Secure

Ijkdijk/Urban Flood

Medical

LifeWatch

CosmoGrid/eVLBI

CineGrid

EU-GN3/NOVI/Geysers

SURFnet/GLIF/Cloud

Green-IT

Privacy/Trust

Authorization/policy

Programmable networks

40-100Gig/TCP/WF/QoS

Topology/Architecture

Optical Photonic

X X

X

X

X X

X X

X

X

X

X

X

X

X

X

X

X

X

X

X

SNE @ UvA

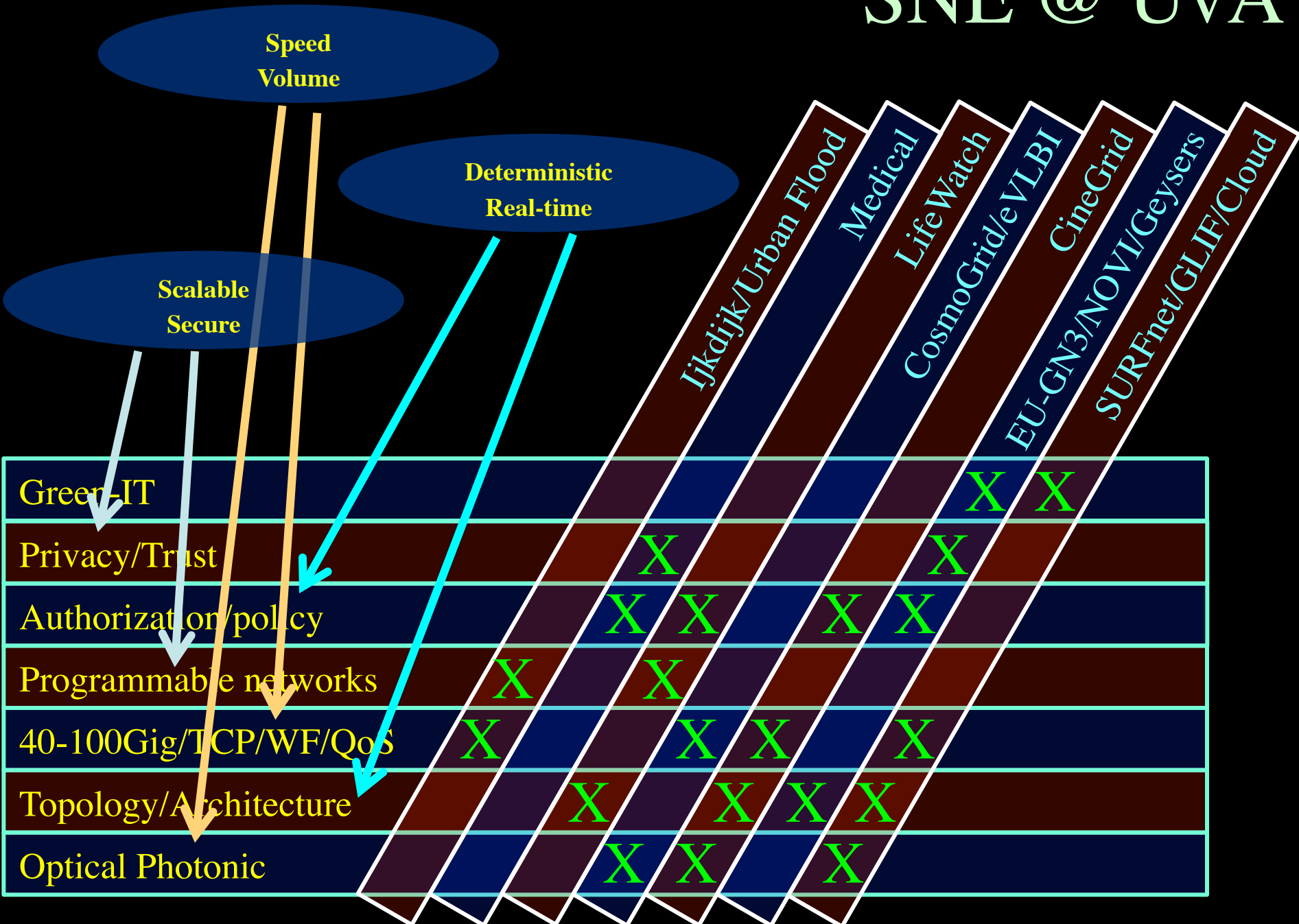

SNE @ UvA

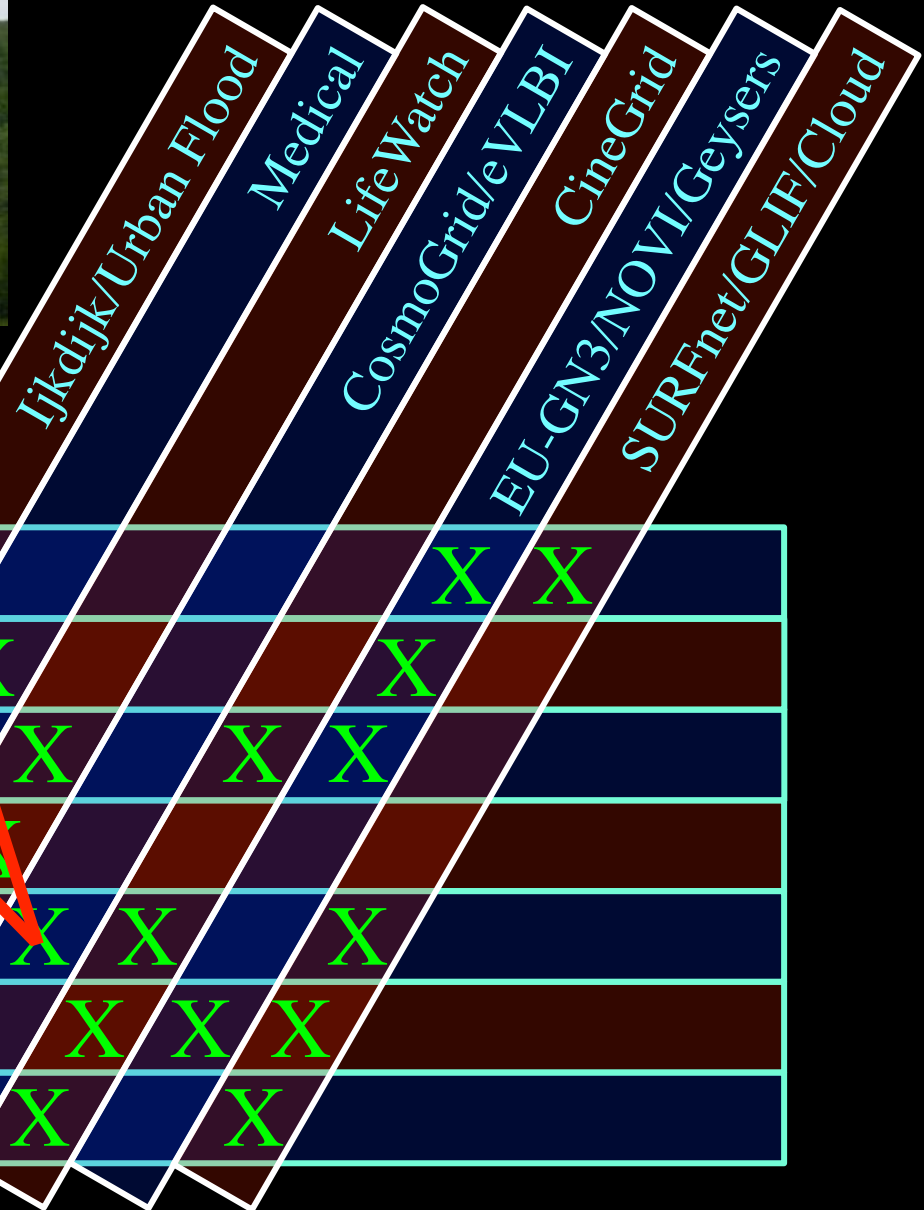

Green-IT						X	X
Privacy/Trust		X				X	
Authorization/policy		X	X		X	X	
Programmable networks	X		X				
40-100Gig/TCP/WF/QoS	X		X	X		X	
Topology/Architecture		X		X	X	X	
Optical Photonic		X	X		X		

e - Very Large Base Interferometer

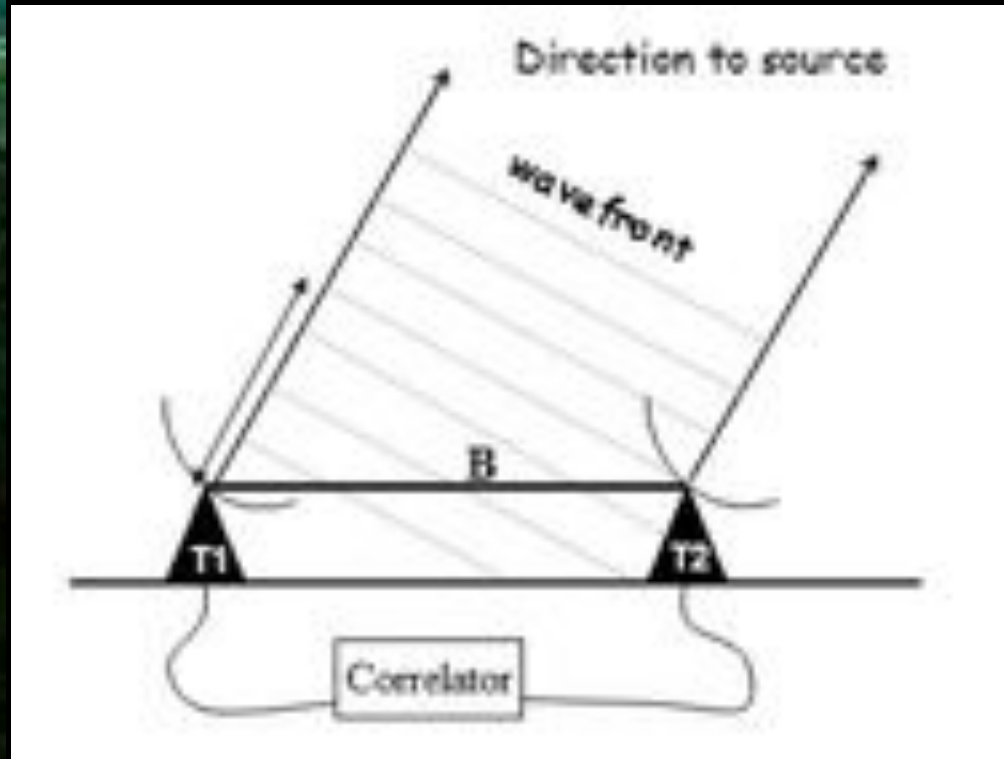



2008

2009

Deadline for submitting observing proposals

Program committee:
* rates proposals
* allocates observing time

VLBI Observing Session

Disks shipped to JIVE

Correlation at JIVE

Data shipped

Data arrives at
at scientist's desk!

Sep | Oct | Nov | Dec | Jan | Feb | Mar | Apr | May | Jun |

2008

2009



eEVN: European VLBI Network

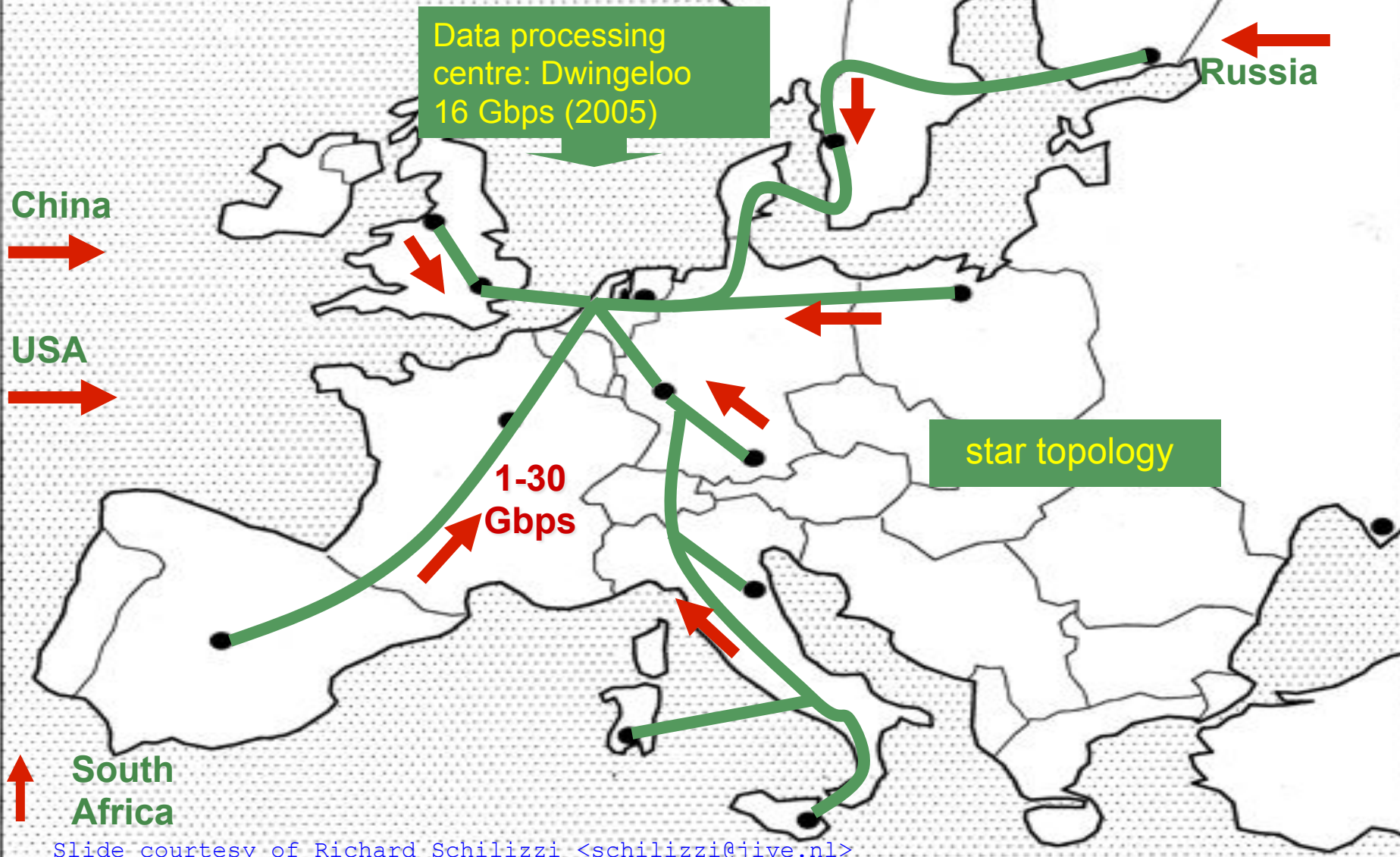

Slide courtesy of Richard Schilizzi <schilizzi@jive.nl>

eVLBI: European VLBI Network

Dec 4

Dec 5

Dec 6

Deadline for submitting eVLBI observing proposals

Program committee decides if eVLBI science can be justified



eVLBI Observing Run

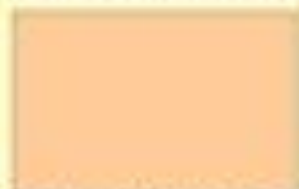

Correlation at JIVE



Scientist downloads data from www.jive.nl

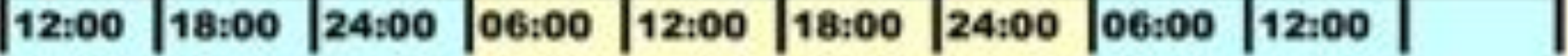

The SCARIE project

SCARIE: a research project to create a Software Correlator for e-VLBI.
VLBI Correlation: signal processing technique to get high precision image from spatially distributed radio-telescope.

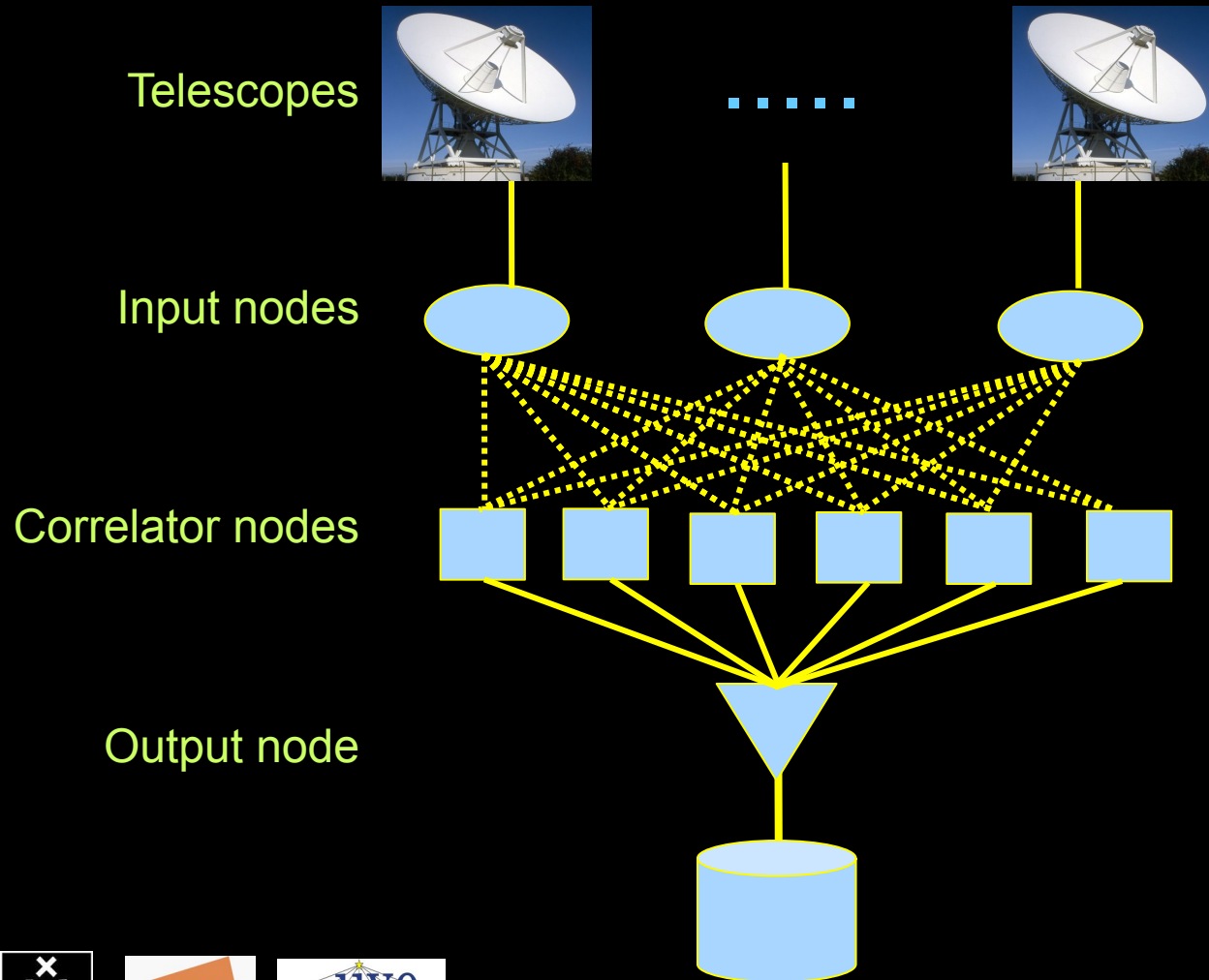

16 Gbit/s - 2 Tflop →
THIS IS A DATA FLOW PROBLEM !!!

Research:

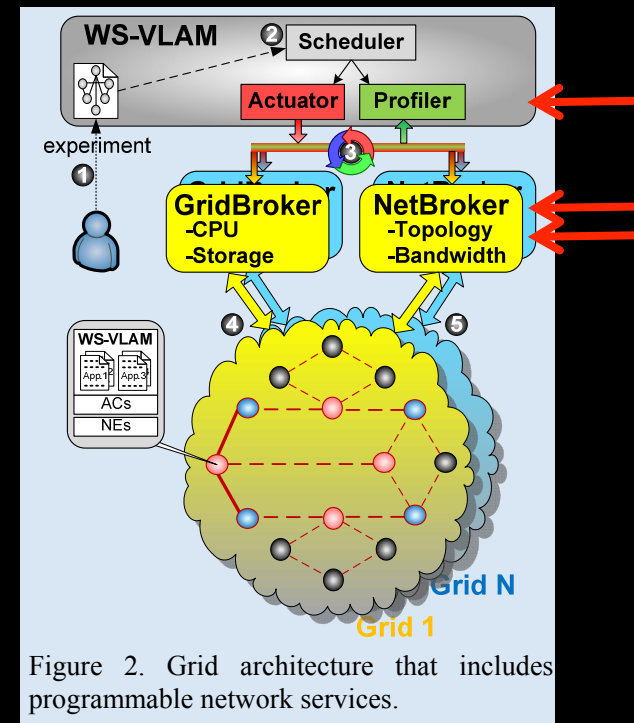
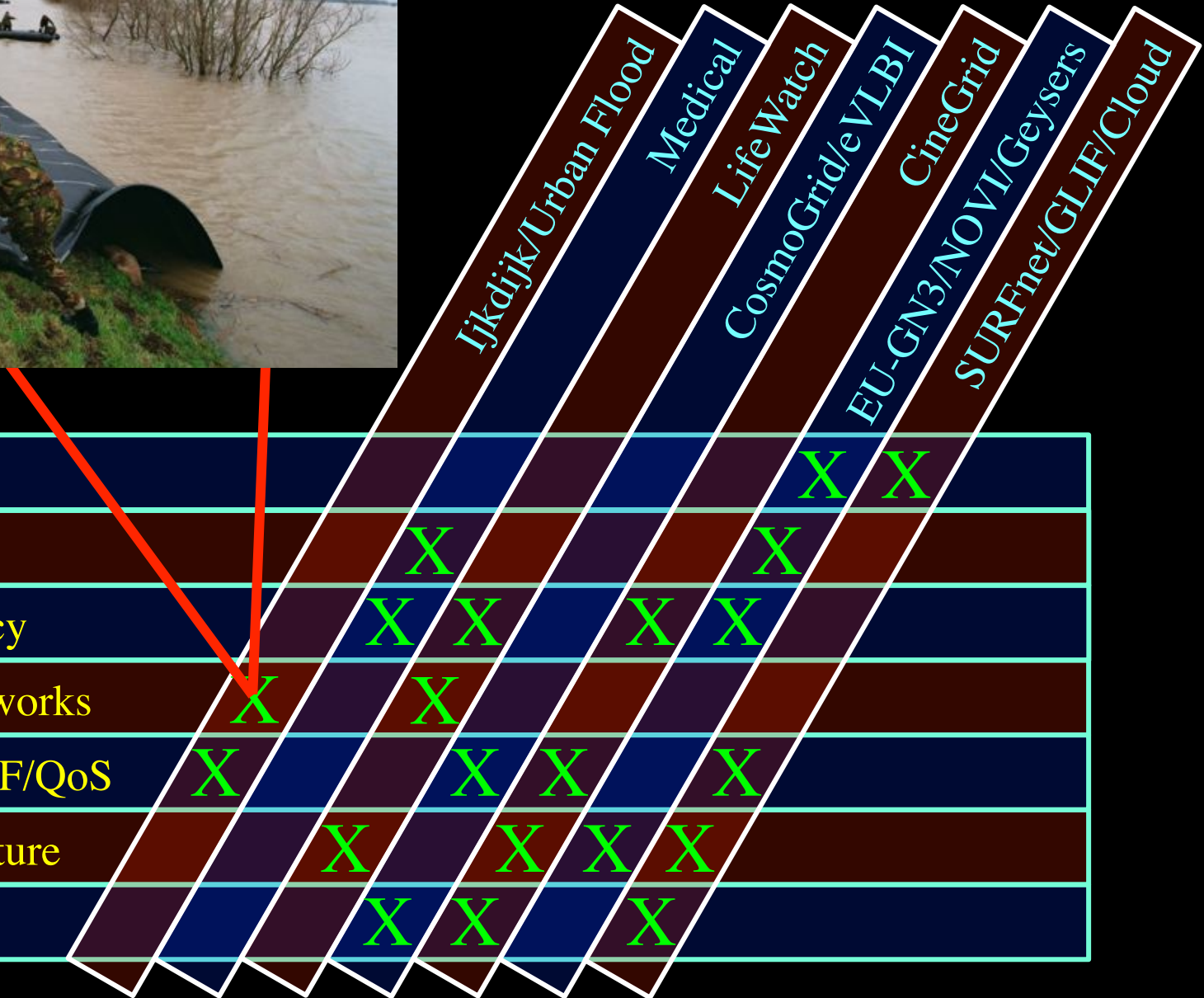

Figure 2. Grid architecture that includes programmable network services.



Where when will it happen?

SNE @ UvA



Green-IT

Privacy/Trust

Authorization/policy

Programmable networks

40-100Gig/TCP/WF/QoS

Topology/Architecture

Optical Photonic

Ijkdijk/Urban Flood

Medical

LifeWatch

CosmoGrid/eVLBI

CineGrid

EU-GN3/NOVI/Geysers

SURFnet/GLIF/Cloud

X

X

X X

X

X

X X

X

X X X

X X

X

X X

X

X X

X

X

X X



IJKDIJK

Sensors: 15000km* 800 bps/m ->12 Gbit/s to cover all Dutch dikes

Sensor grid: instrument the dikes

First controlled breach occurred on sept 27th '08:



Many Pflops/s

Many small flows -> 12 Gb/s

Tera-Thinking

- What constitutes a Tb/s network?
- think back to teraflop computing!
 - MPI turns a room full of pc's in a teraflop machine
- massive parallel channels in hosts, NIC's
- TeraApps programming model supported by
 - TFlops -> MPI / Globus / Cloud
 - TBytes -> DAIS / MONETdb ...
 - TPixels -> SAGE
 - TSensors -> LOFAR, LHC, LOOKING, CineGrid, ...
 - Tbit/s -> ?
 - ? -> Programmable Networks

User Programmable Virtualized Networks.

The network is virtualized as a collection of resources
 UPVNs enable network resources to be programmed
 as part of the application

Mathematica interacts with virtualized networks using
 UPVNs and optimize network + computation

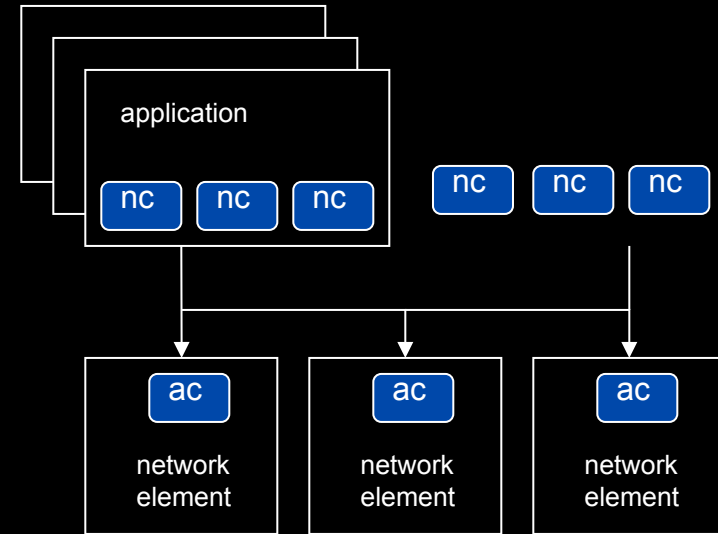

The screenshot shows the Mathematica interface with several input and output cells. The top cell displays the eigenvalues of a matrix: $\begin{pmatrix} -1 & 0 & 2 \\ 2 & 9 & 2 \\ 3 & 1 & 4 \end{pmatrix}$ with numerical results $\{9.484782281, 4.488378526, -1.973160708\}$. The second cell shows a plot of $\text{Sin}[10x]$ over the range $\{x, 0, 2\}$. The third cell shows the simplification of $1 + 5x + 10x^2 + 10x^3 + 5x^4 + x^5$ to $(1+x)^5$. The fourth cell shows a data set $\text{mydata} = \{(0.444539, 0.908491), (1.4486, 1.84577), (1.8734, 1.84577), \dots\}$ and a fit function $\text{Fit}[\text{mydata}, \{1, x, x^2\}, x]$ resulting in $0.2617148495 + 1.007x - 0.0034238343x^2$.

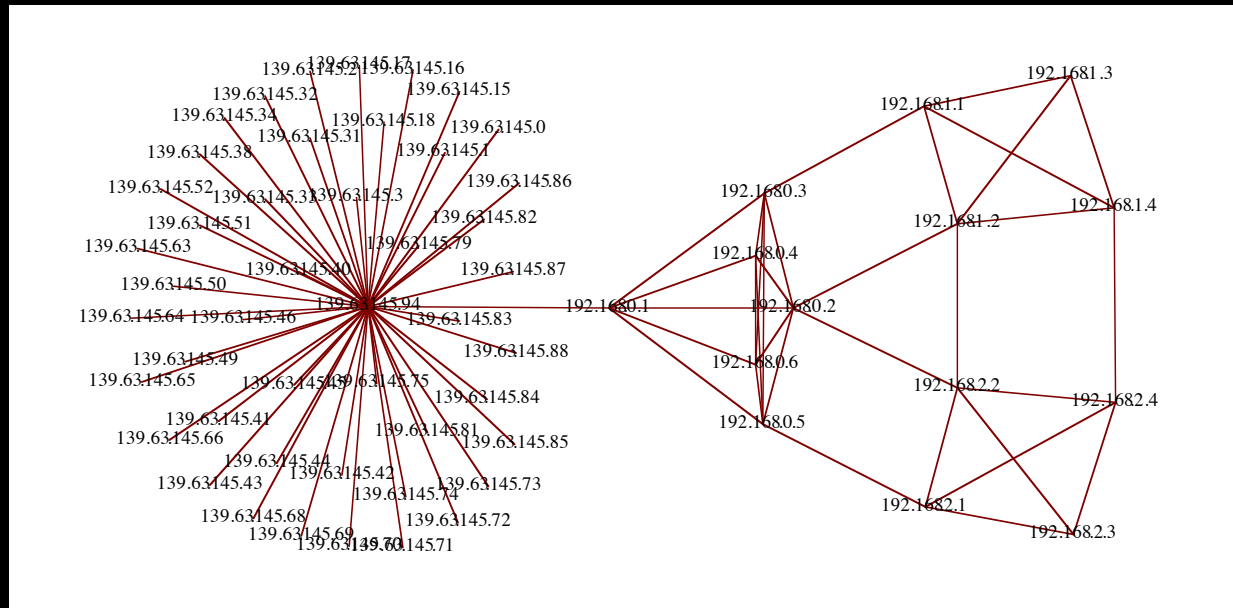

TouchTable Demonstration @ SC08



SNE @ UvA

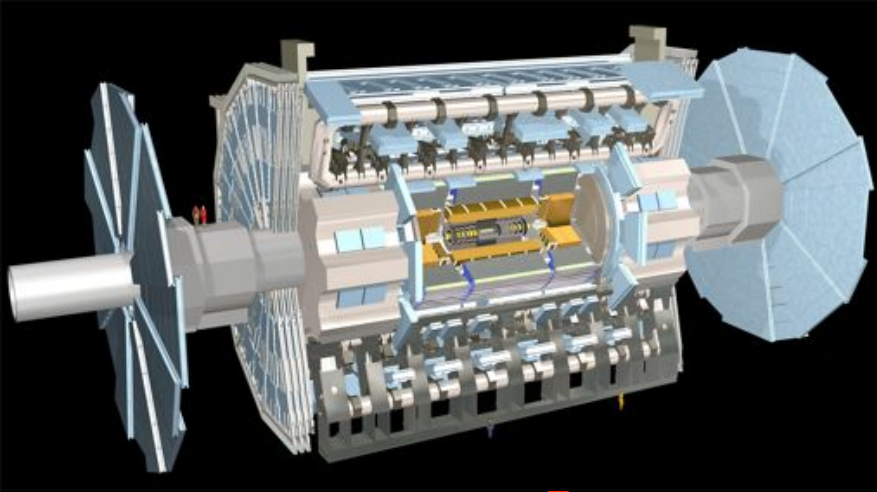

Ijkdijk/Urban Flood

Medical

LifeWatch

CosmoGrid/eVLBI

CineGrid

SURFnet/GLIF/Cloud

Green-IT

Privacy/Trust

Authorization/policy

Programmable networks

40-100Gig/TCP/WF/QoS

Topology/Architecture

Optical Photonic

X X

X

X

X X

X X

X

X

X

X X

X

X

X

X

X

X

X

X

ATLAS detector @ CERN Geneve

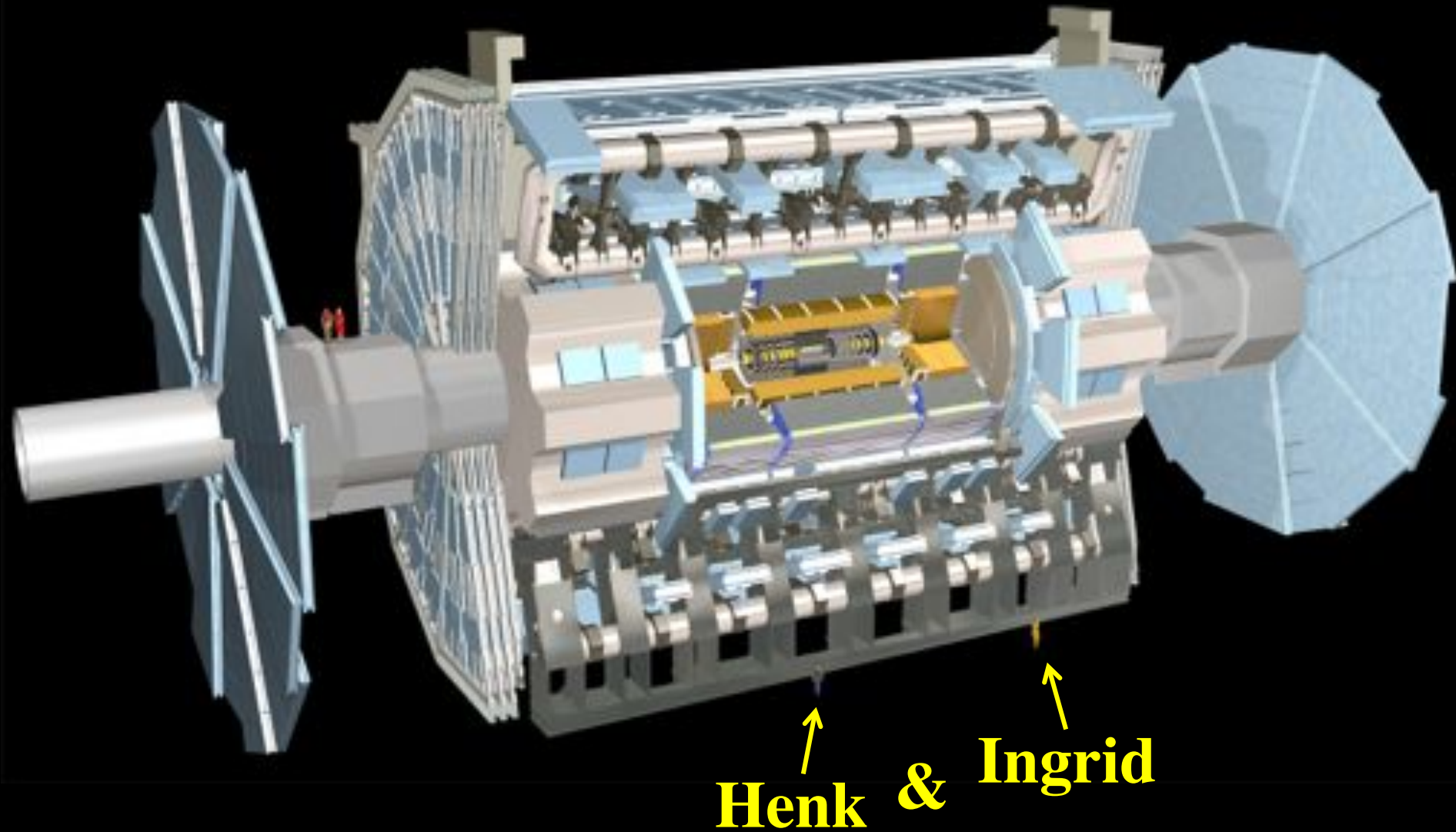

ATLAS detector @ CERN Geneve



One Heavy Ion Collision in Atlas!

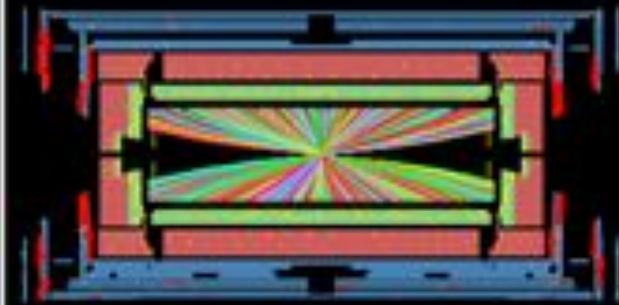
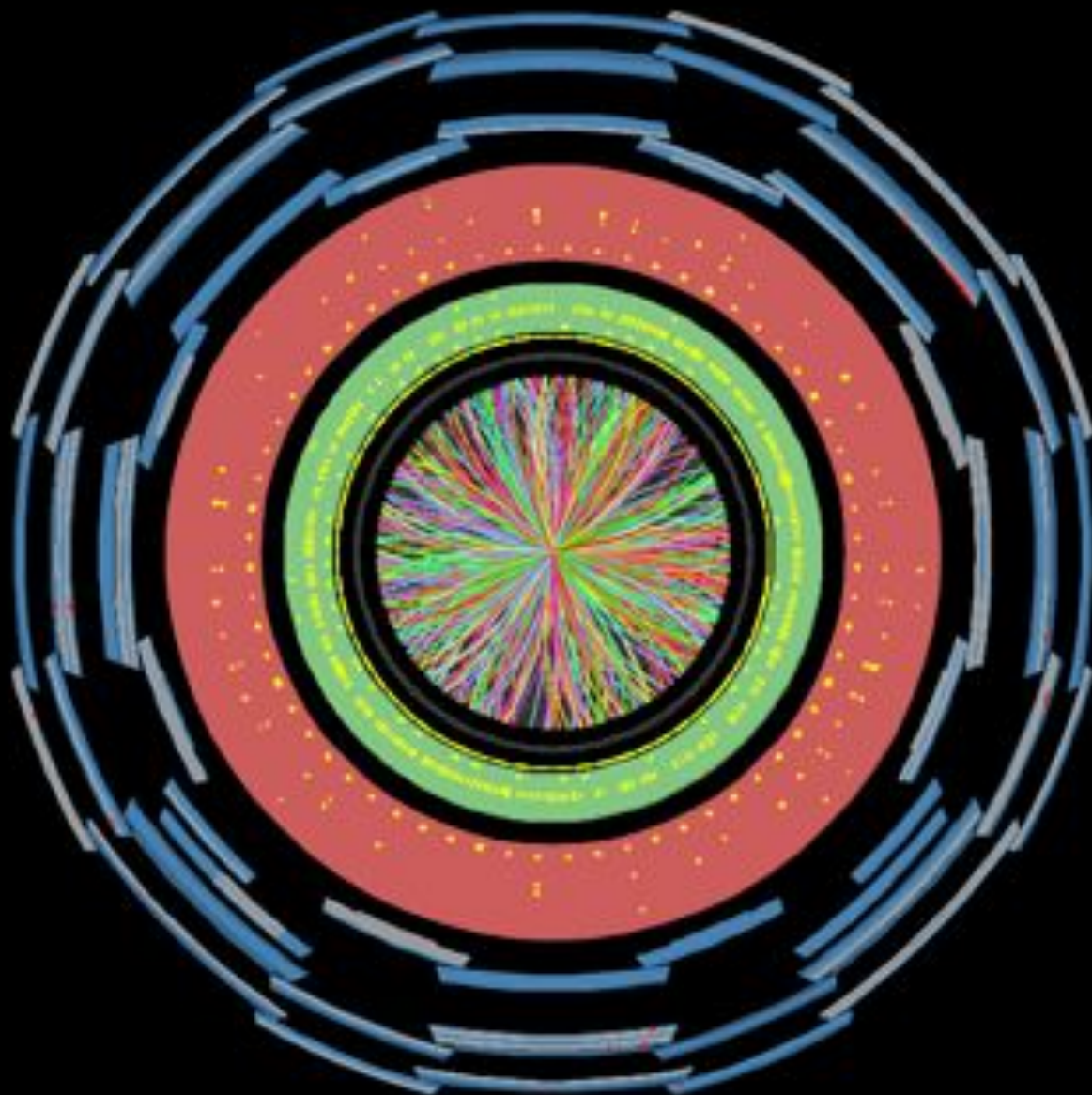

 **ATLAS**
EXPERIMENT

Run Number: 170482, Event Number: 3936308

Date: 2010-12-06 17:21:31 CET

Snapshot of a heavy ion collision
directly from the ATLAS experiment



LHC Data Grid Hierarchy

CMS as example, Atlas is similar

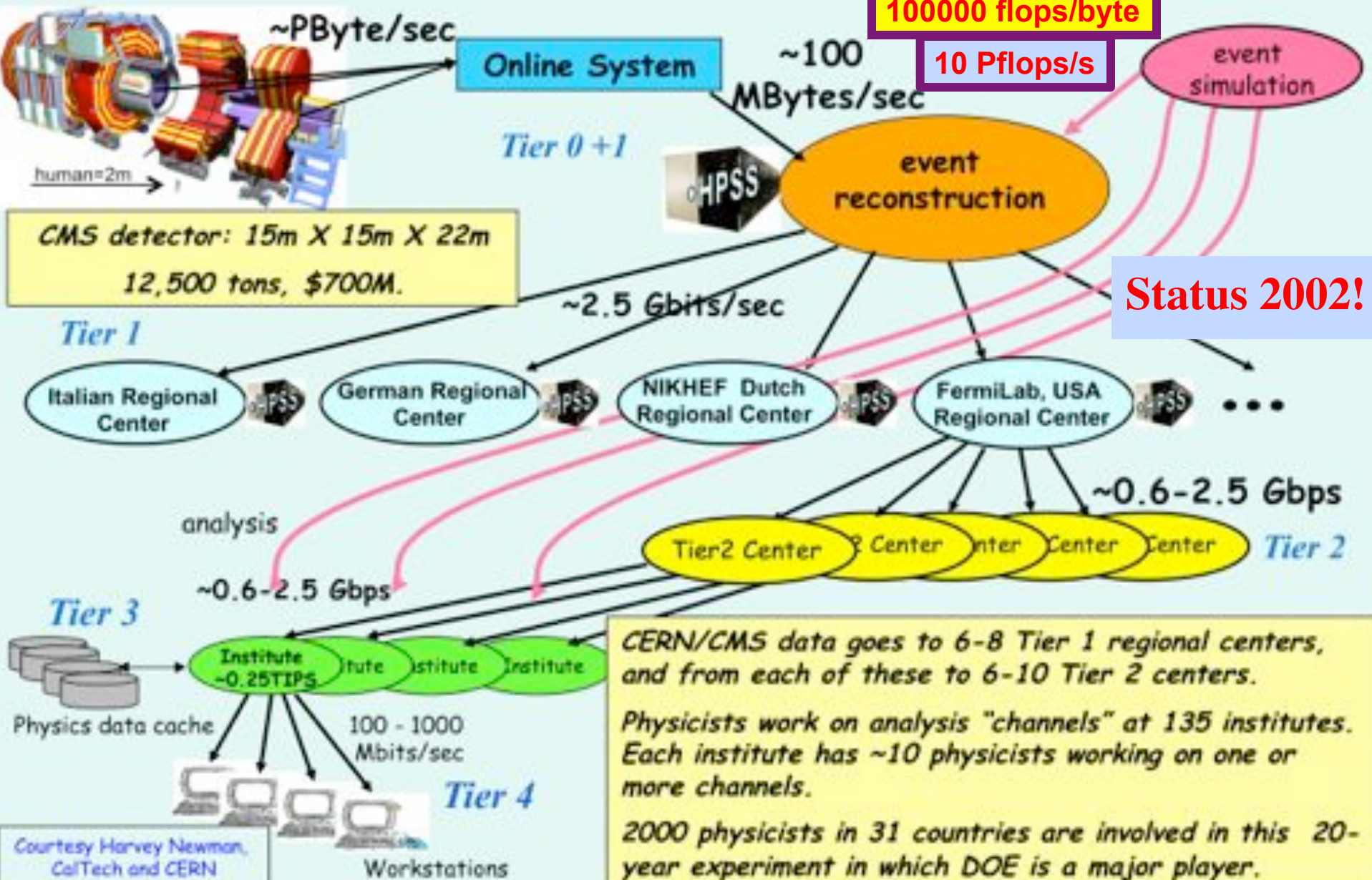

Courtesy Harvey Newman, CalTech and CERN

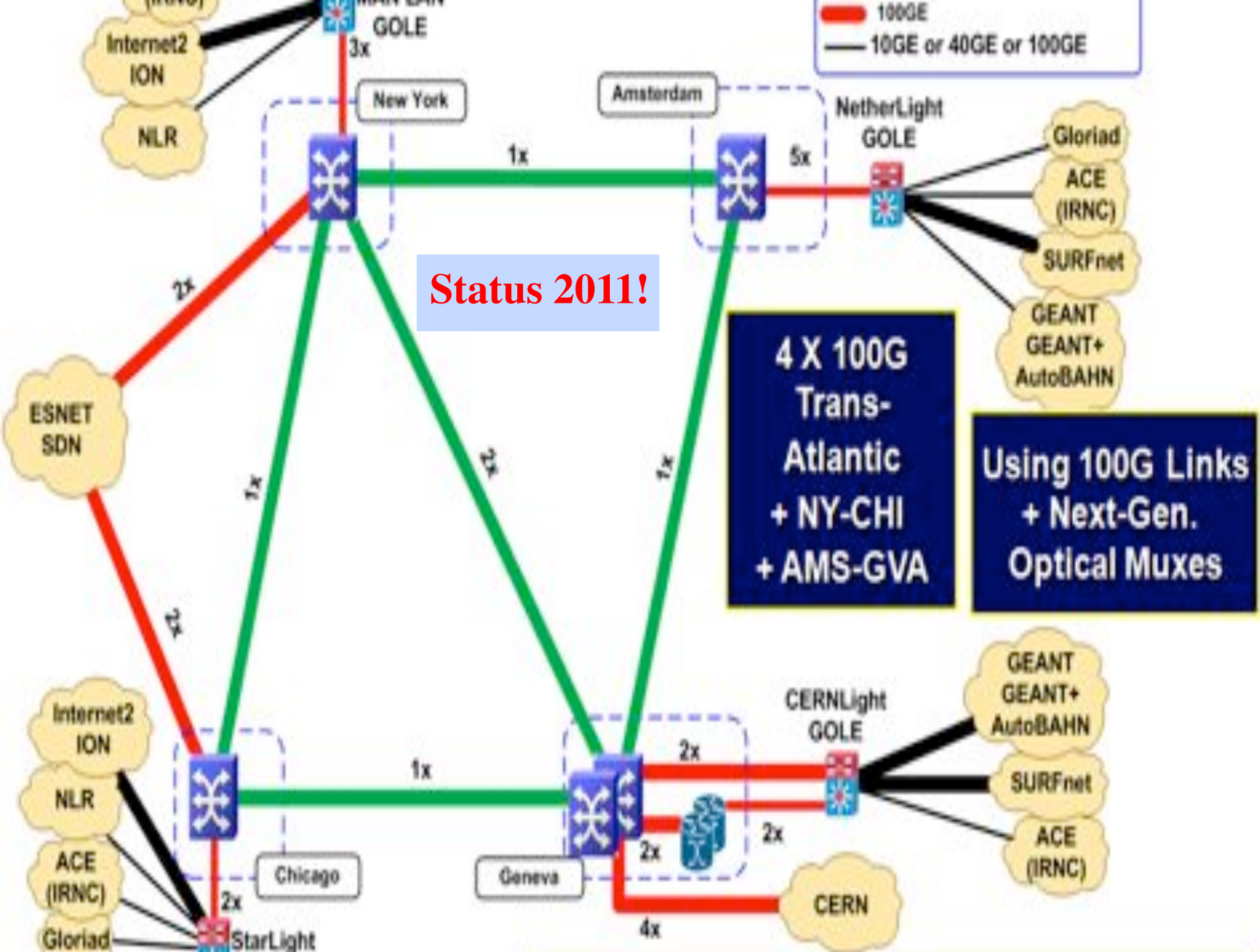

Big and small flows don't go well together on the same wire! ☹



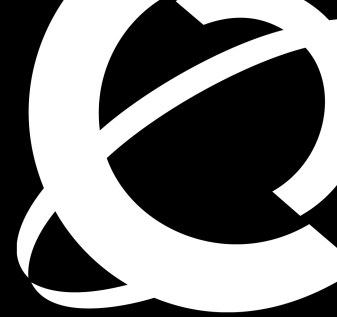
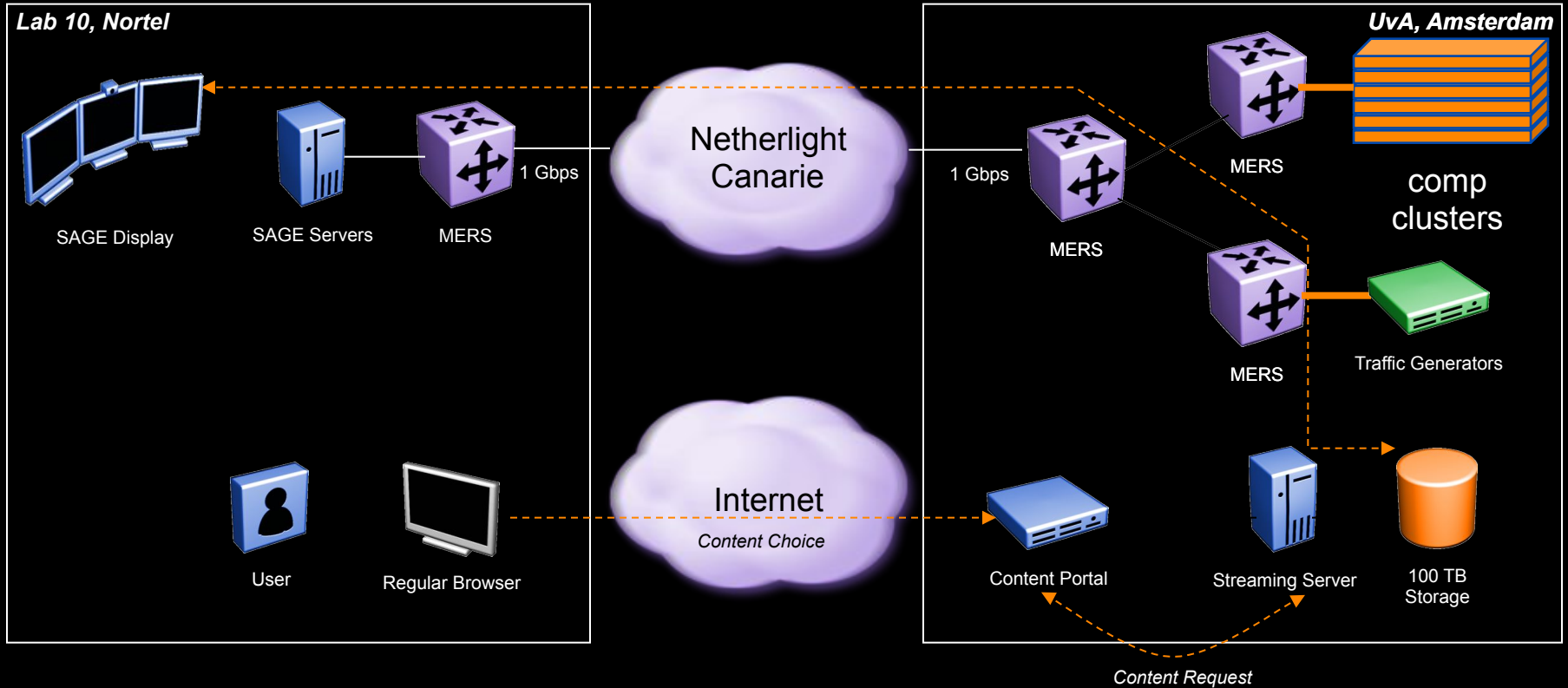

Diagram for SAGE video streaming to ATS



Experimental Data



Sage without
background
traffic

Sage with
background
traffic

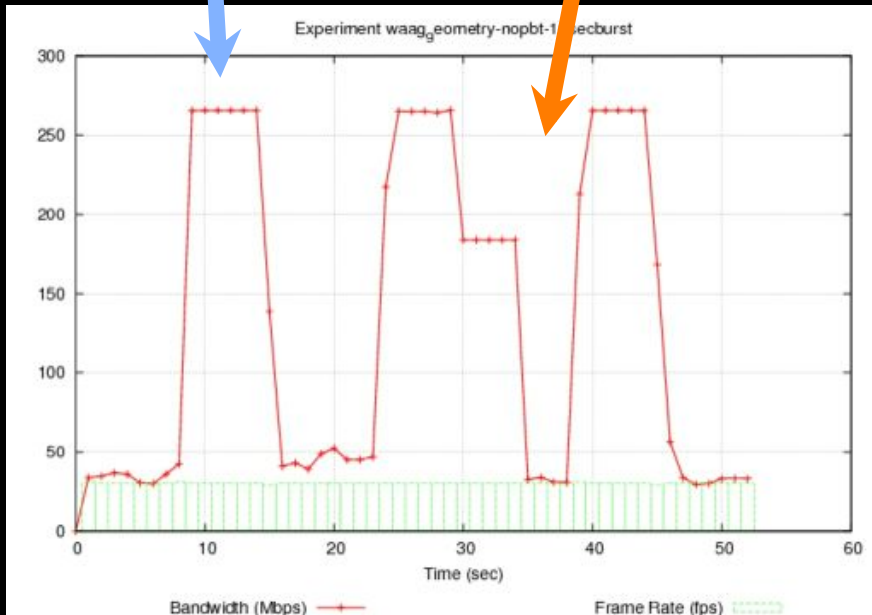

10 Second Traffic
bursts with No PBT

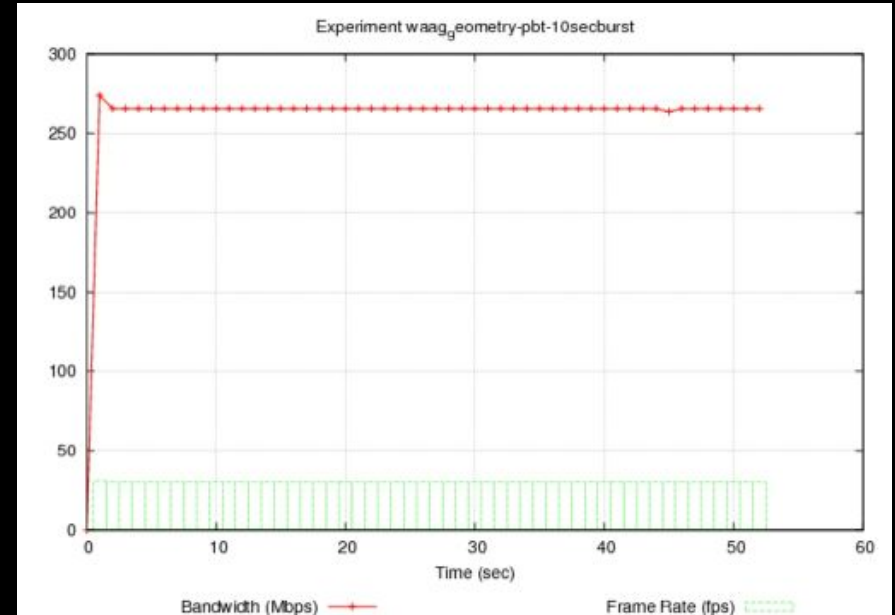

10 Second Traffic
bursts with PBT

PBT is SIMPLE and EFFECTIVE
technology to build a shared Media-Ready Network



Alien light From idea to realisation!

40Gb/s alien wavelength transmission via a multi-vendor 10Gb/s DWDM infrastructure



Alien wavelength advantages

- Direct connection of customer equipment^[1] → cost savings
- Avoid OEO regeneration → power savings
- Faster time to service^[2] → time savings
- Support of different modulation formats^[3] → extend network lifetime

Alien wavelength challenges

- Complex end-to-end optical path engineering in terms of linear (i.e. OSNR, dispersion) and non-linear (FWM, SPM, XPM, Raman) transmission effects for different modulation formats.
- Complex interoperability testing.
- End-to-end monitoring, fault isolation and resolution.
- End-to-end service activation.

In this demonstration we will investigate the performance of a 40Gb/s PM-QPSK alien wavelength installed on a 10Gb/s DWDM infrastructure.

New method to present fiber link quality, FoM (Figure of Merit)

In order to quantify optical link grade, we propose a new method of representing system quality: the FOM (Figure of Merit) for concatenated fiber spans.

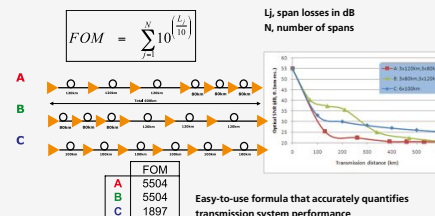

Transmission system setup

JOINT SURFnet/NORDUnet 40Gb/s PM-QPSK alien wavelength DEMONSTRATION.

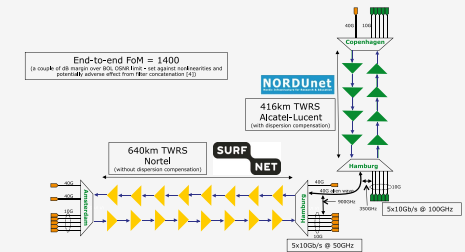

Test results

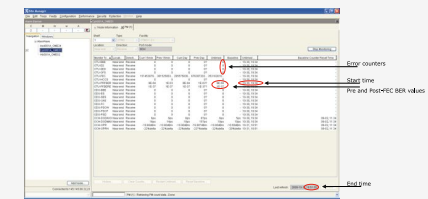

Error-free transmission for 23 hours, 17 minutes → BER < 3,0 · 10⁻¹⁶

Conclusions

- We have investigated experimentally the all-optical transmission of a 40Gb/s PM-QPSK alien wavelength via a concatenated native and third party DWDM system that both were carrying live 10Gb/s wavelengths.
- The end-to-end transmission system consisted of 1056 km of TWRS (TrueWave Reduced Slope) transmission fiber.
- We demonstrated error-free transmission (i.e. BER below 10⁻¹⁵) during a 23 hour period.
- More detailed system performance analysis will be presented in an upcoming paper.



REFERENCES
ACKNOWLEDGEMENTS

[1] "OPERATIONAL SOLUTIONS FOR AN OPEN DWDM LAYER", O. GERSTEL ET AL. OFC2009 | [2] "AT&T OPTICAL TRANSPORT SERVICES", BARBARA E. SMITH, OFC'09
[3] "OPEX SAVINGS OF ALL-OPTICAL CORE NETWORKS", ANDREW LORD AND CARL ENGINEER, ECCO2009 | [4] NORTEL/SURFNET INTERNAL COMMUNICATION
WE ARE GRATEFUL TO NORDUNET FOR PROVIDING US WITH BANDWIDTH ON THEIR DWDM LINK FOR THIS EXPERIMENT AND ALSO FOR THEIR SUPPORT AND ASSISTANCE DURING THE EXPERIMENTS. WE ALSO ACKNOWLEDGE TELINDUS AND NORTEL FOR THEIR INTEGRATION WORK AND SIMULATION SUPPORT

Alien light From idea to realisation!

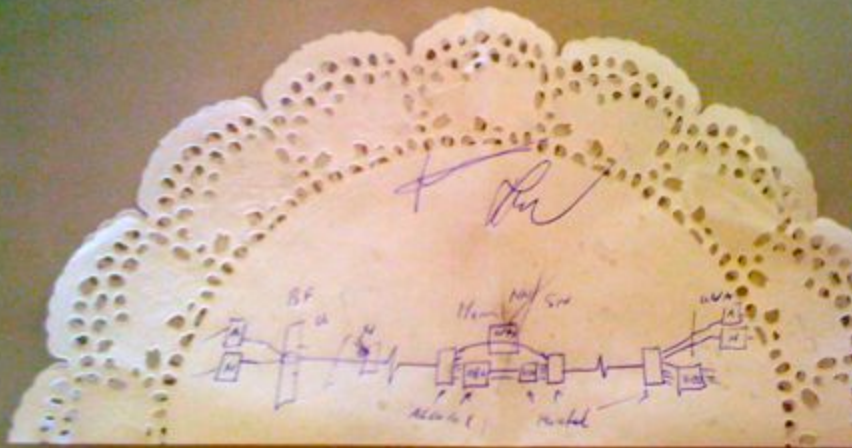

40Gb/s alien wavelength transmission via a multi-vendor 10Gb/s DWDM infrastructure



Alien wavelength advantages

- Direct connection of customer equipment^[1] → cost savings
- Avoid OEO regeneration → power savings
- Faster time to service^[2] → time savings
- Support of different modulation formats^[3] → extend network lifetime

Alien wavelength challenges

- Complex end-to-end optical path engineering in terms of linear (i.e. OSNR, dispersion) and non-linear (FWM, SPM, XPM, Raman) transmission effects for different modulation formats.
- Complex interoperability testing.
- End-to-end monitoring, fault isolation and resolution.
- End-to-end service activation.

In this demonstration we will investigate the performance of a 40Gb/s PM-QPSK alien wavelength installed on a 10Gb/s DWDM infrastructure.

New method to present fiber link quality, FoM (Figure of Merit)

In order to quantify optical link grade, we propose a new method of representing system quality: the FOM (Figure of Merit) for concatenated fiber spans.

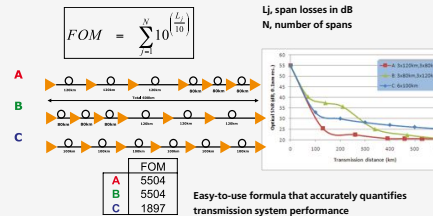

Transmission system setup

JOINT SURFnet/NORDUnet 40Gb/s PM-QPSK alien wavelength DEMONSTRATION.

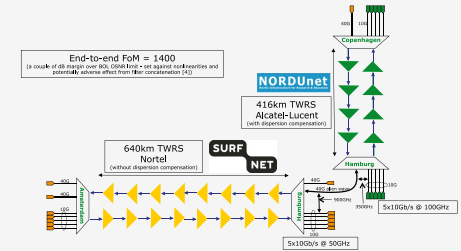

Test results

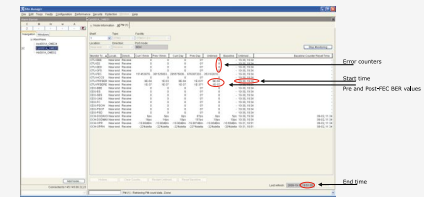

Error-free transmission for 23 hours, 17 minutes → BER < 3,0 · 10⁻¹⁶

Conclusions

- We have investigated experimentally the all-optical transmission of a 40Gb/s PM-QPSK alien wavelength via a concatenated native and third party DWDM system that both were carrying live 10Gb/s wavelengths.
- The end-to-end transmission system consisted of 1056 km of TWRS (TrueWave Reduced Slope) transmission fiber.
- We demonstrated error-free transmission (i.e. BER below 10⁻¹⁵) during a 23 hour period.
- More detailed system performance analysis will be presented in an upcoming paper.



REFERENCES
ACKNOWLEDGEMENTS

[1] "OPERATIONAL SOLUTIONS FOR AN OPEN DWDM LAYER", O. GERSTEL ET AL. OFC2009 | [2] "AT&T OPTICAL TRANSPORT SERVICES", BARBARA E. SMITH, OFC'09
[3] "OPEX SAVINGS OF ALL-OPTICAL CORE NETWORKS", ANDREW LORD AND CARL ENGINEER, ECCO2009 | [4] NORTEL/SURFNET INTERNAL COMMUNICATION
WE ARE GRATEFUL TO NORDUNET FOR PROVIDING US WITH BANDWIDTH ON THEIR DWDM LINK FOR THIS EXPERIMENT AND ALSO FOR THEIR SUPPORT AND ASSISTANCE DURING THE EXPERIMENTS. WE ALSO ACKNOWLEDGE TELINDUS AND NORTEL FOR THEIR INTEGRATION WORK AND SIMULATION SUPPORT

ClearStream @ TNC2011

Setup codename:
FlightCees



UvA

iPerf I7 3.2 GHz Q-core iPerf Amd Ph II 3.6 GHz HexC

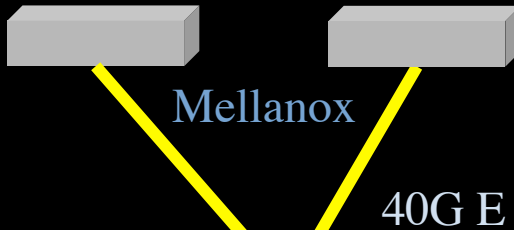

Copenhagen

iPerf 2* dual 2.8 GHz Q-core iPerf



CERN

CIENA DWDM

Hamburg

Alcatel DWDM



Amsterdam – Geneva (CERN) – Copenhagen – 4400 km (2700 km alien light)

Demo setup codename: FlightCees



Ciena ActiveFlex(OME)
6500

Broadcom 40GE 18 port L2
Ethernet Switch

Supermicro Intel Server

Dell R815 Server

Visit CIENA Booth

surf to <http://tnc11.delaat.net>

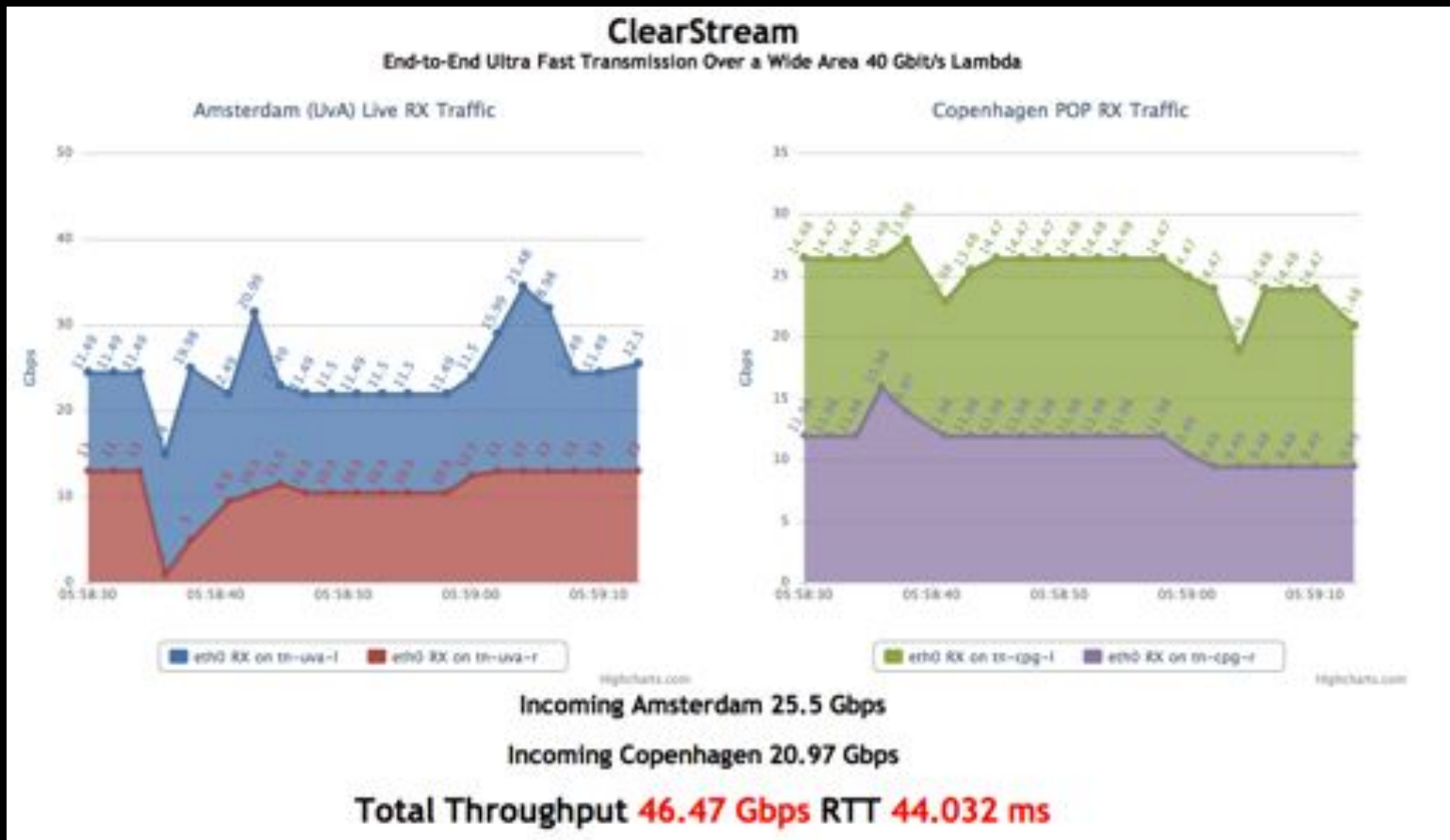

From GLIF October 2010 @ CERN

```

2.28e+07 2.34e+07
2.28e+07 2.34e+07
2.28e+07 2.34e+07
2.28e+07 2.34e+07
2.28e+07 2.34e+07
2.28e+07 2.34e+07
2.28e+07 2.34e+07
2.28e+07 2.34e+07
2.28e+07 2.34e+07
2.28e+07 2.34e+07
5.55e+06 2.49e+07
2.27e+07 2.34e+07
eth2
Kbps in Kbps out
2.28e+07 2.34e+07
2.28e+07 2.34e+07
2.28e+07 2.34e+07
2.28e+07 2.34e+07

```

UvA

```

1.02e+07 1.08e+07
9.79e+06 9.13e+06
6.52e+06 6.52e+06
2.28e+06 3.32e+06
2.59e+06 2.13e+06
1.09e+07 1.05e+07
1.04e+07 1.06e+07
7.80e+06 7.61e+06
3.44e+06 4.29e+06
35741.16 32136.81
3.63e+06 3.05e+06
1.07e+07 1.05e+07
eth0
Kbps in Kbps out
8.75e+06 8.74e+06
2.25e+06 3.13e+06

```

```

2.34e+07 2.28e+07
2.34e+07 2.28e+07
2.34e+07 2.28e+07
2.34e+07 2.28e+07
2.34e+07 2.28e+07
2.34e+07 2.28e+07
2.34e+07 2.28e+07
2.39e+07 1.57e+07
2.43e+07 1.26e+07
2.34e+07 2.28e+07
2.34e+07 2.28e+07
2.34e+07 2.28e+07
2.34e+07 2.28e+07
eth0
Kbps in Kbps out
2.34e+07 2.28e+07

```

CERN

```

1.98e+07 1.02e+07
9.23e+06 9.80e+06
6.55e+06 6.53e+06
3.47e+06 2.33e+06
1.89e+06 2.57e+06
1.04e+07 1.09e+07
1.06e+07 1.04e+07
eth0
Kbps in Kbps out
7.73e+06 7.81e+06
4.44e+06 3.48e+06
32517.03 35833.66
2.79e+06 3.60e+06
1.05e+07 1.07e+07
8.86e+06 8.76e+06
3.26e+06 2.28e+06

```

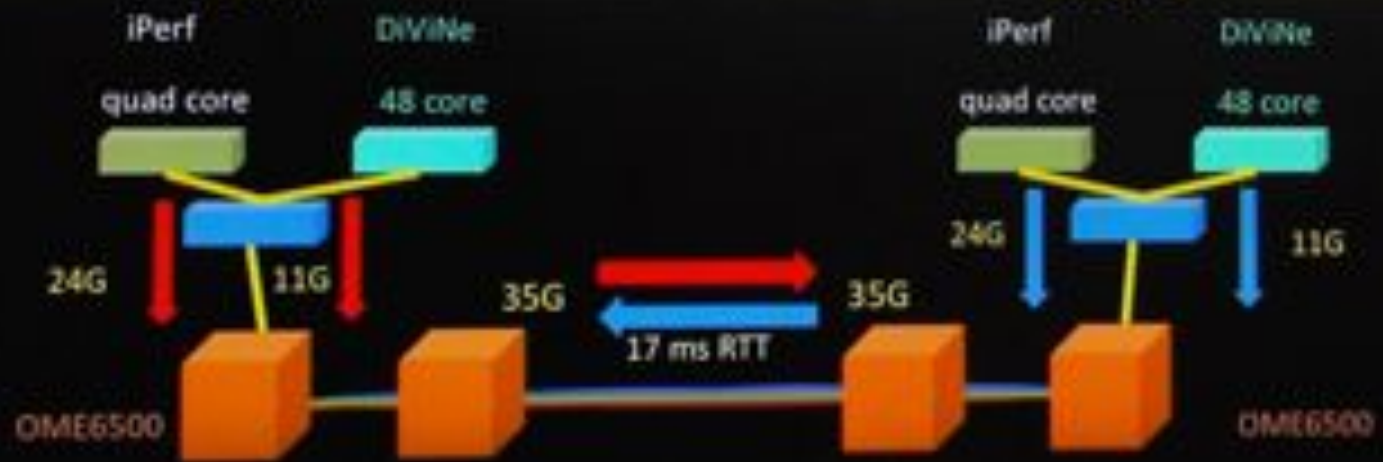

Results (rtt = 17 ms)

- Single flow iPerf 1 core -> 21 Gbps
- Single flow iPerf 1 core <> -> 15+15 Gbps
- Multi flow iPerf 2 cores -> 25 Gbps
- Multi flow iPerf 2 cores <> -> 23+23 Gbps
- DiViNe <> -> 11 Gbps
- Multi flow iPerf + DiVine -> 35 Gbps
- Multi flow iPerf + DiVine <> -> 35 + 35 Gbps

Performance Explained

- Mellanox 40GE card is PCI-E 2.0 8x (5GT/s)
- 40Gbit/s raw throughput but
- PCI-E is a network-like protocol
 - 8/10 bit encoding -> 25% overhead -> 32Gbit/s maximum data throughput
 - Routing information
- Extra overhead from IP/Ethernet framing
- Server architecture matters!
 - 4P system performed worse in multithreaded iperf

Server Architecture

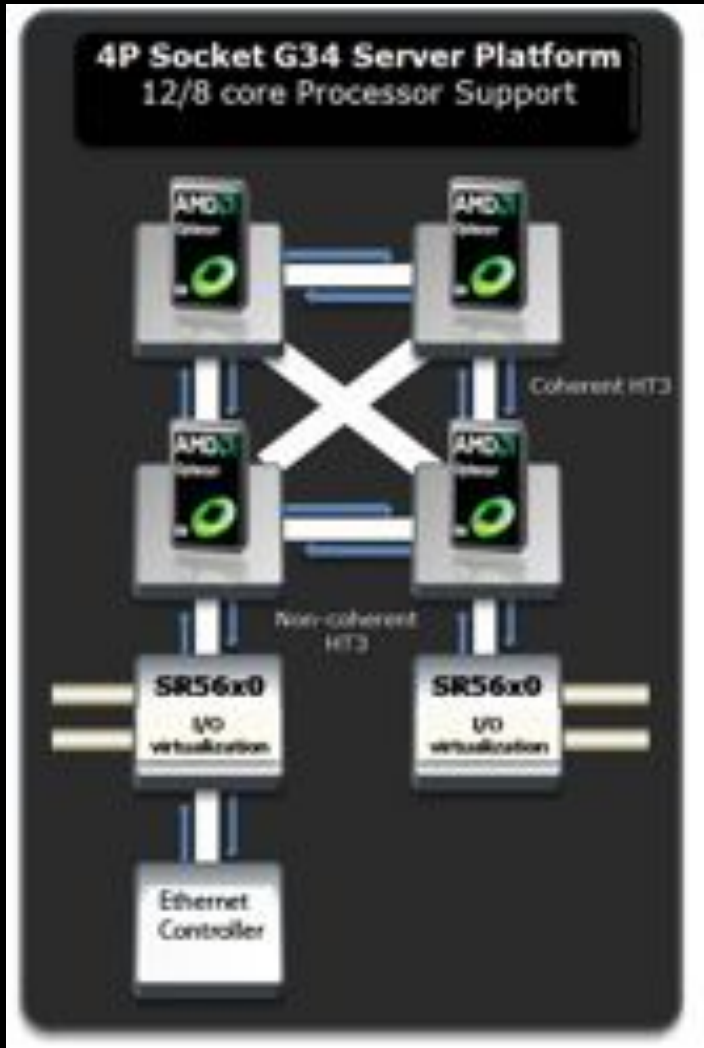

DELL R815

4 x AMD Opteron 6100

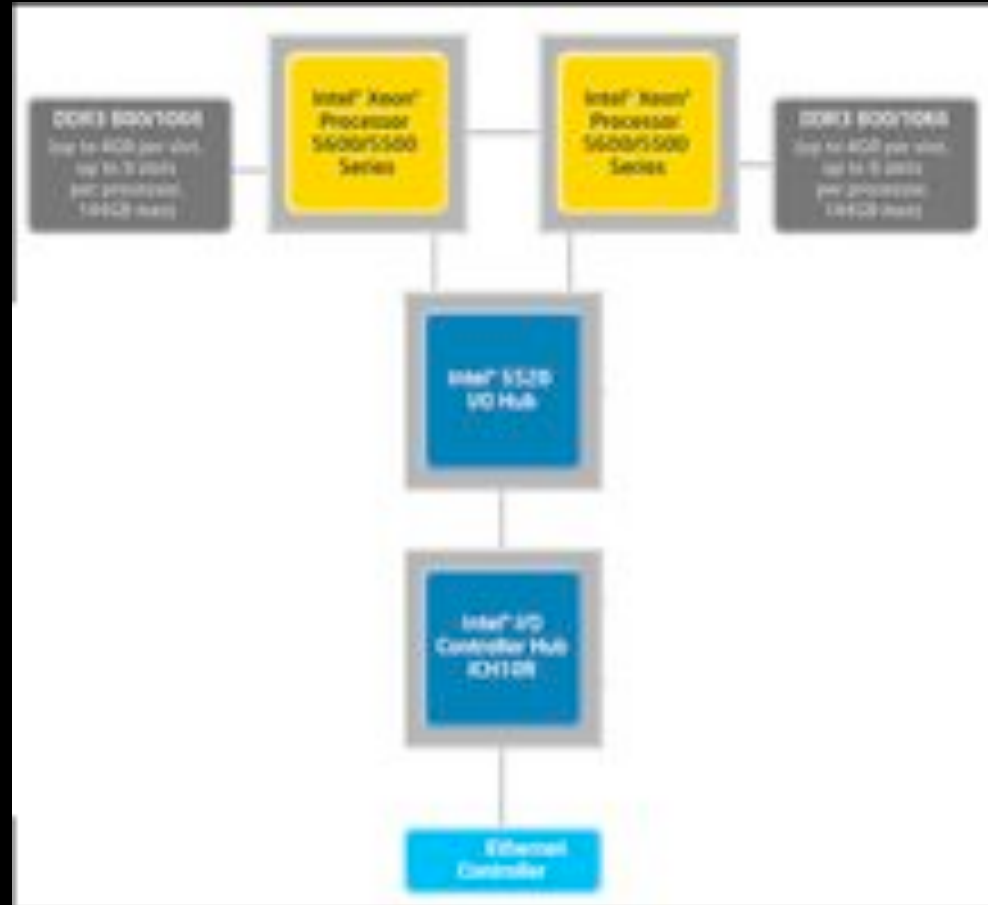

Supermicro X8DTT-HIBQF

2 x Intel Xeon

CPU Topology benchmark

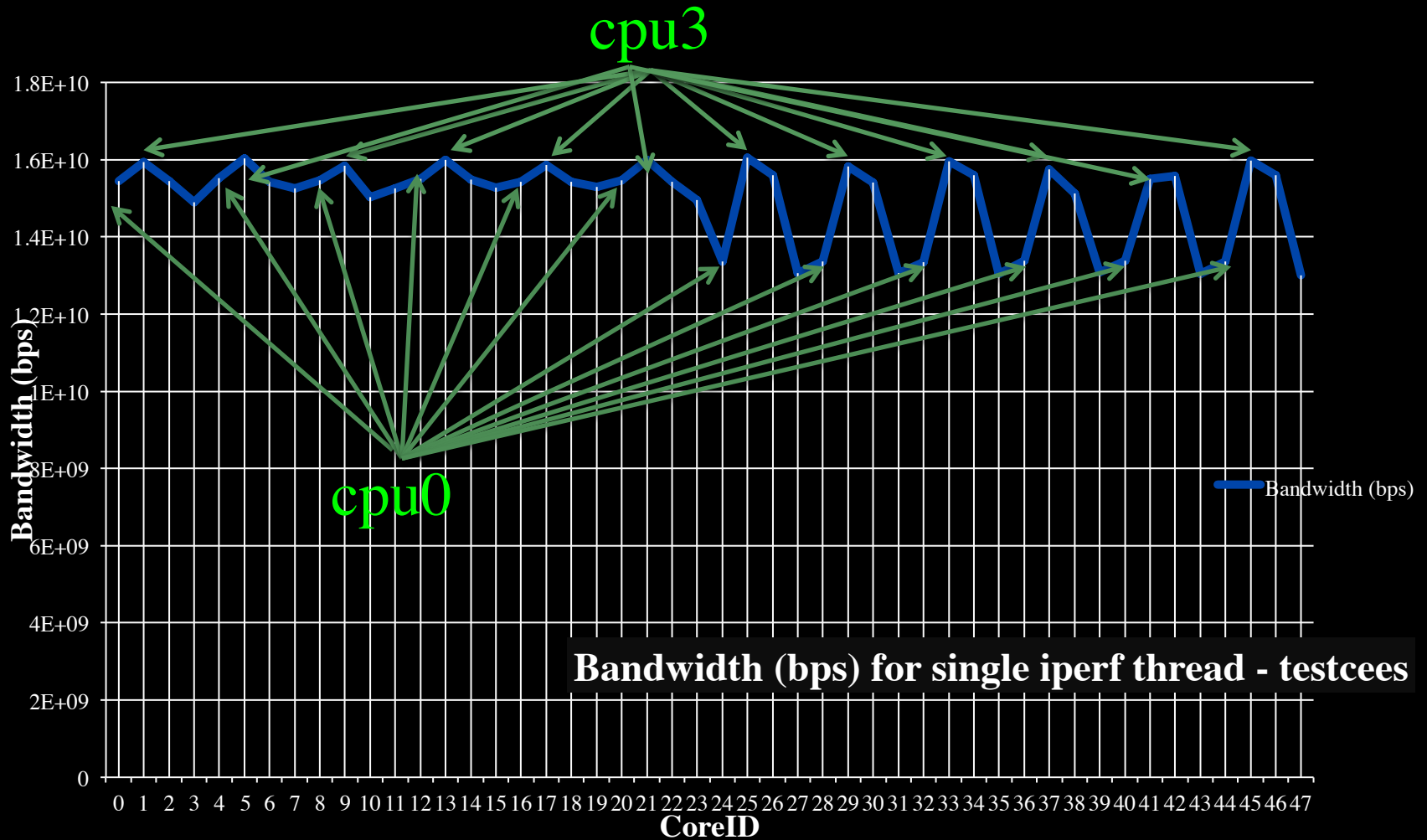

We used numactl to bind iperf to cores



© 2008 The University of Chicago. All rights reserved. This work is licensed under a Creative Commons Attribution-NonCommercial-ShareAlike 3.0 License. For more information, see <http://creativecommons.org/licenses/by-nc-sa/3.0/>.



GLIF 2008

**Visualization courtesy of Bob Patterson, NCSA
Data collection by Maxine Brown.**



We investigate:
complex networks!



for



LinkedIn for Infrastructure



- From semantic Web / Resource Description Framework.
- The RDF uses XML as an interchange syntax.
- Data is described by triplets (Friend of a Friend):

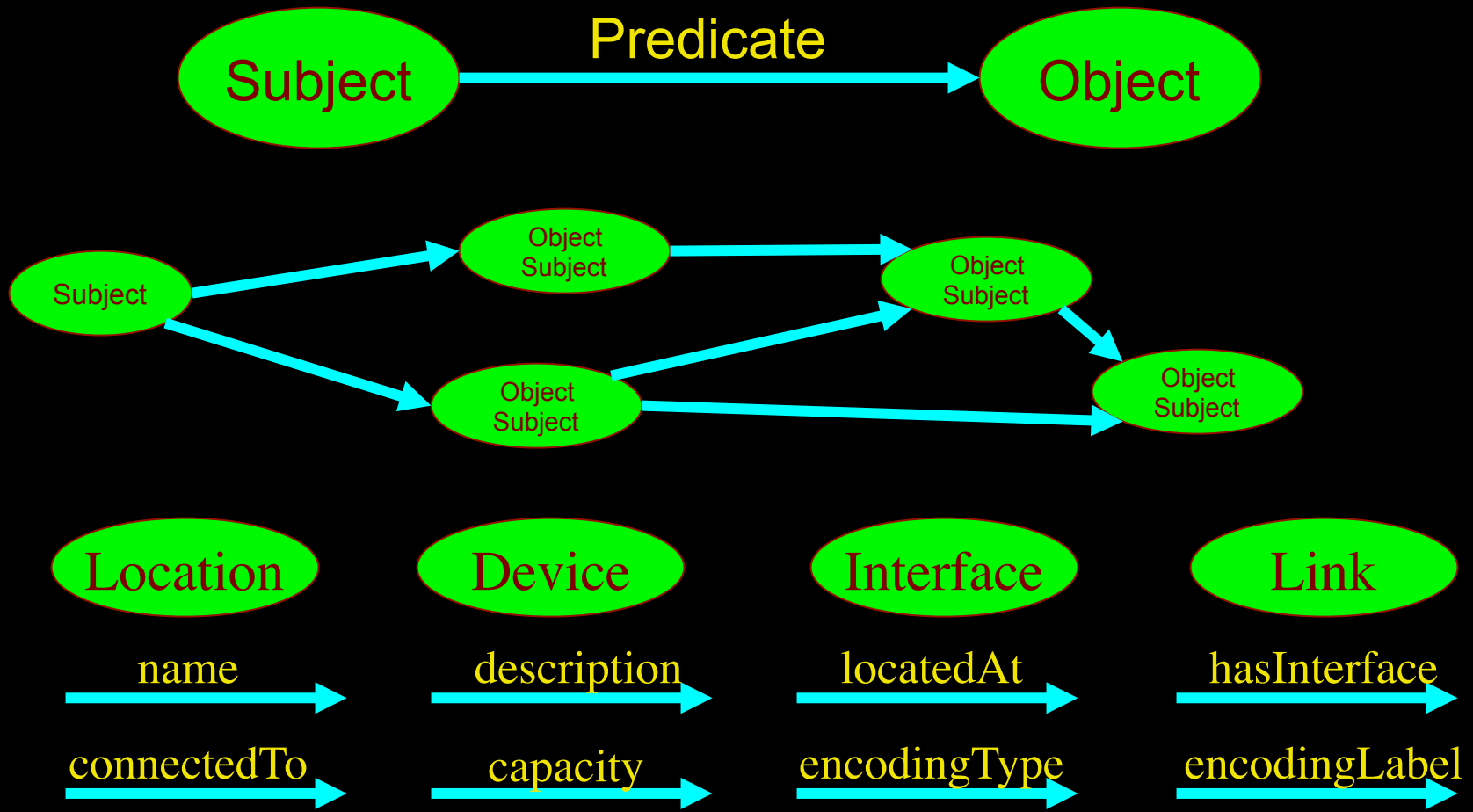

NetherLight in RDF

```
<?xml version="1.0" encoding="UTF-8"?>
<rdf:RDF xmlns:rdf="http://www.w3.org/1999/02/22-rdf-syntax-ns#"
  xmlns:ndl="http://www.science.uva.nl/research/air/ndl#">
  <!-- Description of Netherlight -->
  <ndl:Location rdf:about="#Netherlight">
    <ndl:name>Netherlight Optical Exchange</ndl:name>
  </ndl:Location>
  <!-- TDM3.amsterdam1.netherlight.net -->
  <ndl:Device rdf:about="#tdm3.amsterdam1.netherlight.net">
    <ndl:name>tdm3.amsterdam1.netherlight.net</ndl:name>
    <ndl:locatedAt rdf:resource="#amsterdam1.netherlight.net"/>
    <ndl:hasInterface rdf:resource="#tdm3.amsterdam1.netherlight.net:501/1"/>
    <ndl:hasInterface rdf:resource="#tdm3.amsterdam1.netherlight.net:501/3"/>
    <ndl:hasInterface rdf:resource="#tdm3.amsterdam1.netherlight.net:501/4"/>
    <ndl:hasInterface rdf:resource="#tdm3.amsterdam1.netherlight.net:503/1"/>
    <ndl:hasInterface rdf:resource="#tdm3.amsterdam1.netherlight.net:503/2"/>
    <!-- all the interfaces of TDM3.amsterdam1.netherlight.net -->
    <ndl:Interface rdf:about="#tdm3.amsterdam1.netherlight.net:501/1">
      <ndl:name>tdm3.amsterdam1.netherlight.net:POS501/1</ndl:name>
      <ndl:connectedTo rdf:resource="#tdm4.amsterdam1.netherlight.net:5/1"/>
    </ndl:Interface>
    <ndl:Interface rdf:about="#tdm3.amsterdam1.netherlight.net:501/2">
      <ndl:name>tdm3.amsterdam1.netherlight.net:POS501/2</ndl:name>
      <ndl:connectedTo rdf:resource="#tdm1.amsterdam1.netherlight.net:12/1"/>
    </ndl:Interface>
```

Multi-layer descriptions in NDL

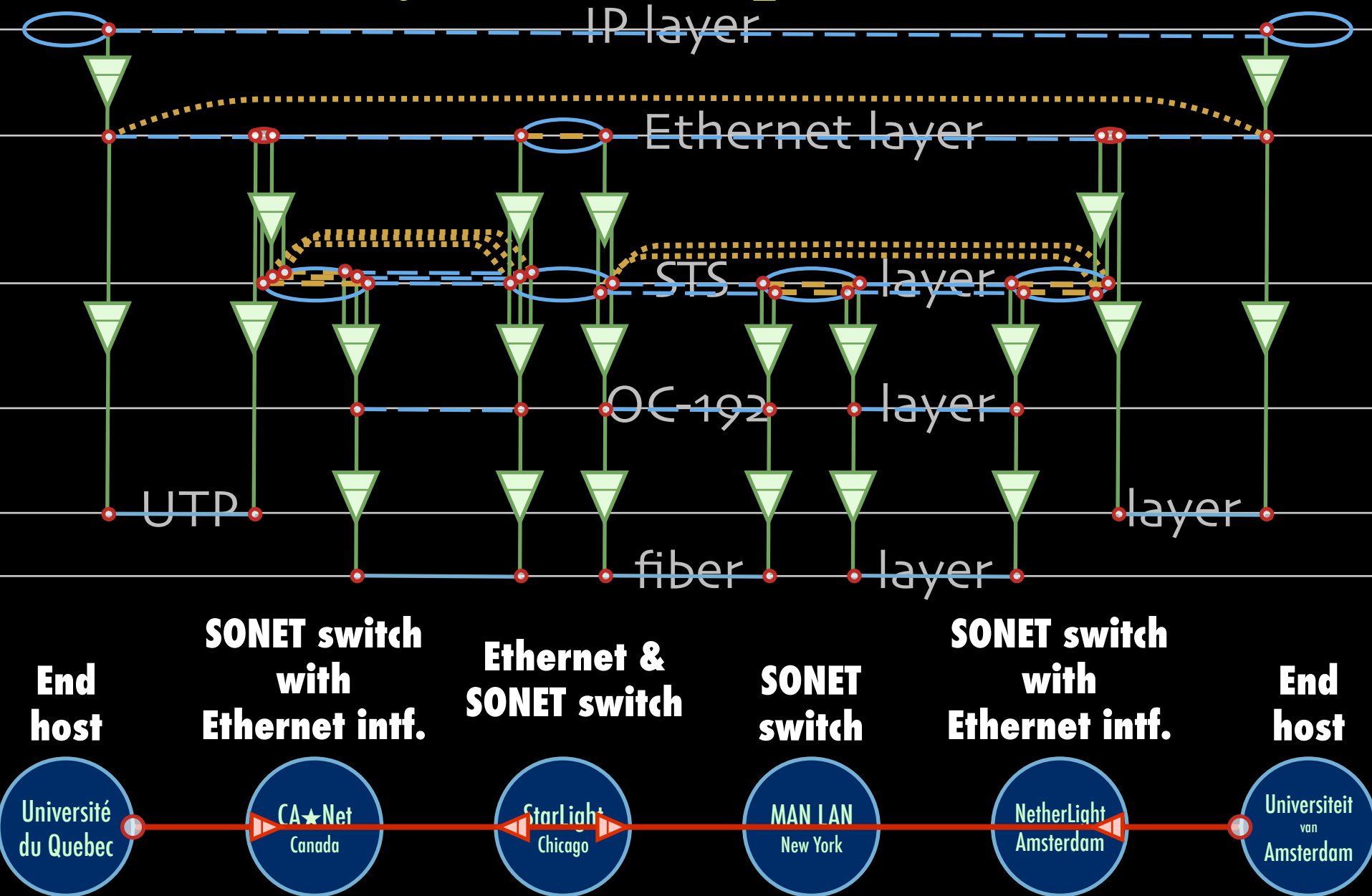

Multi-layer Network PathFinding

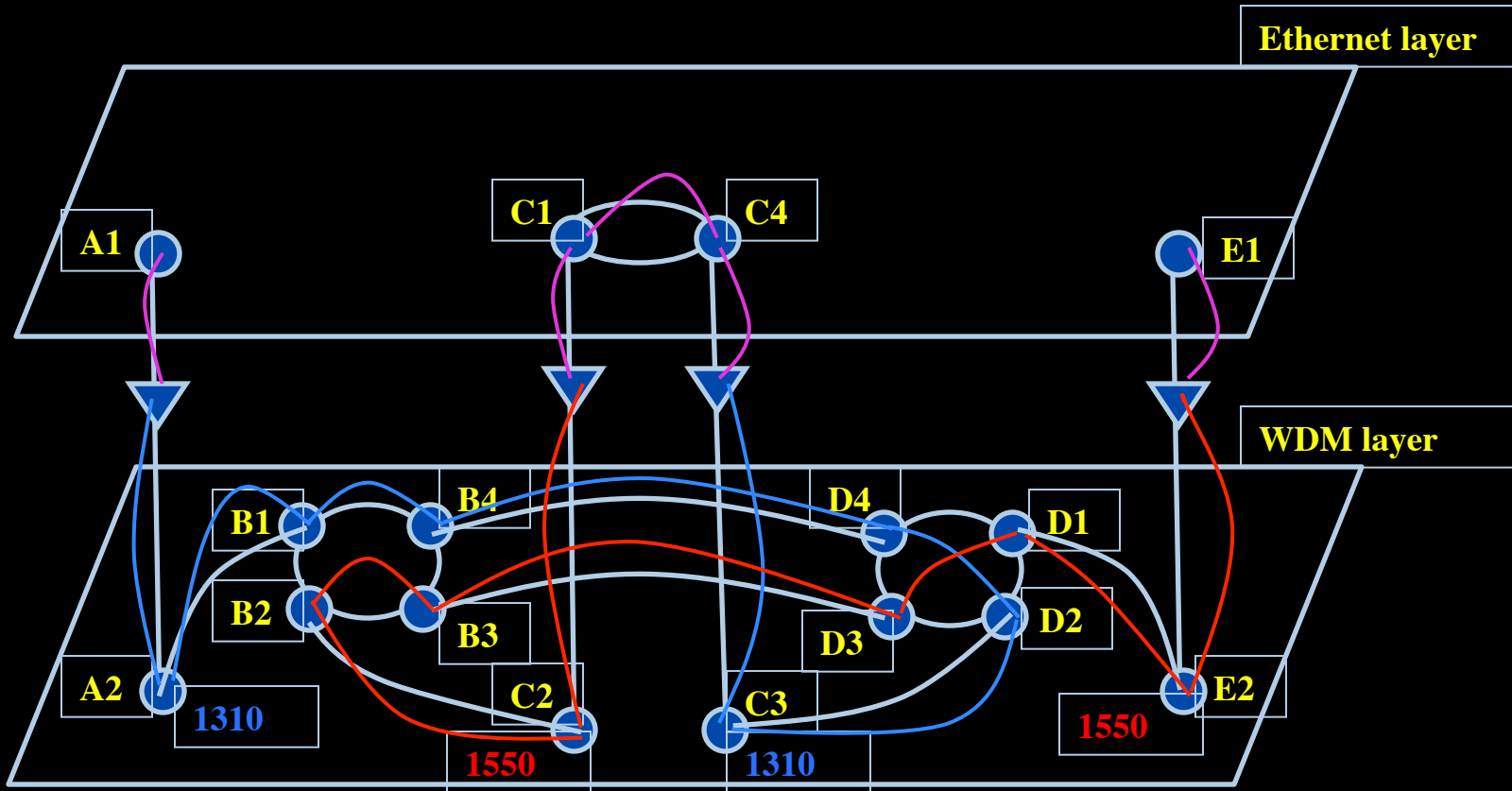

Path between interfaces A1 and E1:

A1-A2-B1-B4-D4-D2-C3-C4-C1-C2-B2-B3-D3-D1-E2-E1

Scaling: Combinatorial problem

Virtualisatie van infrastructuur & QoS

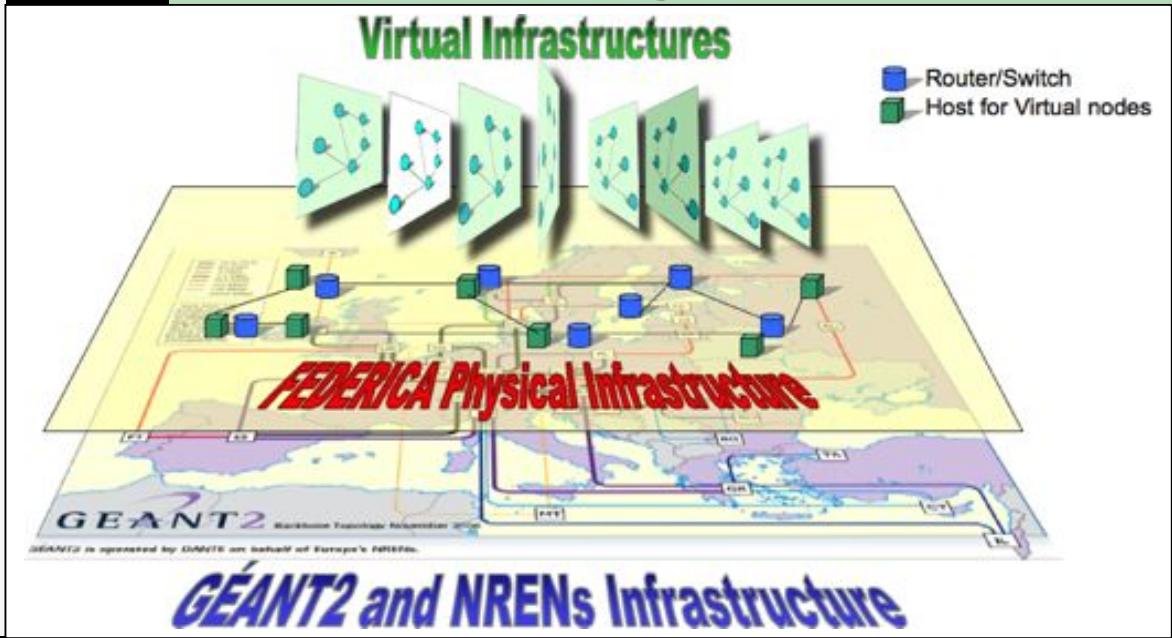
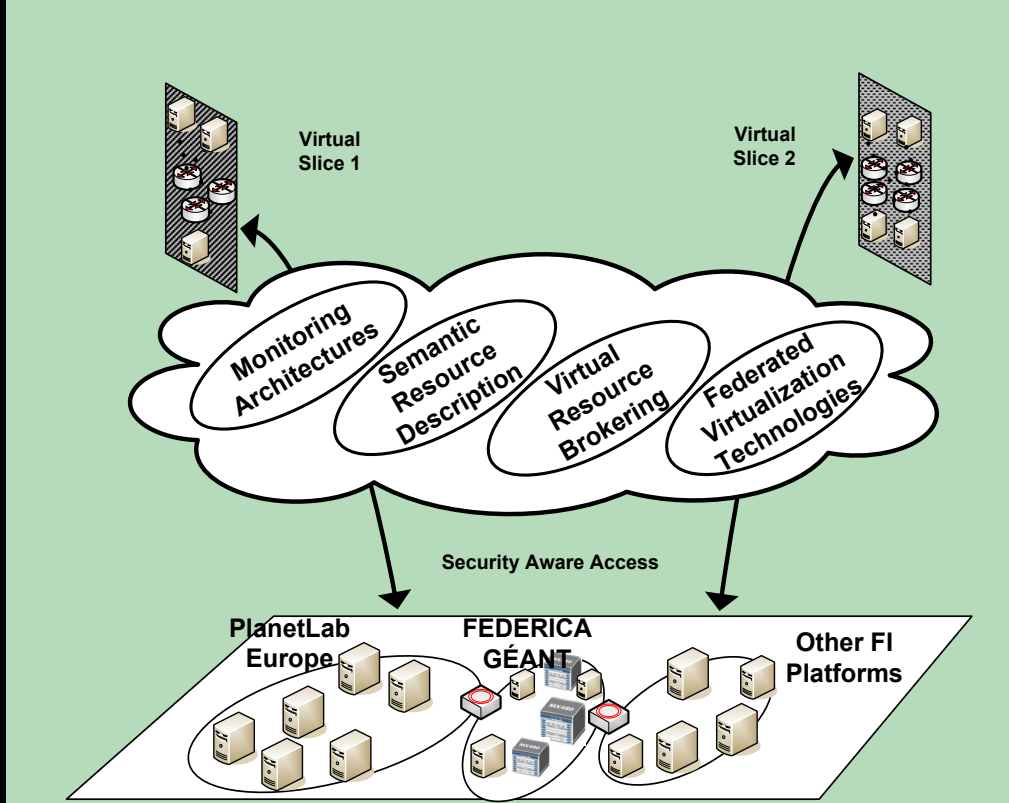
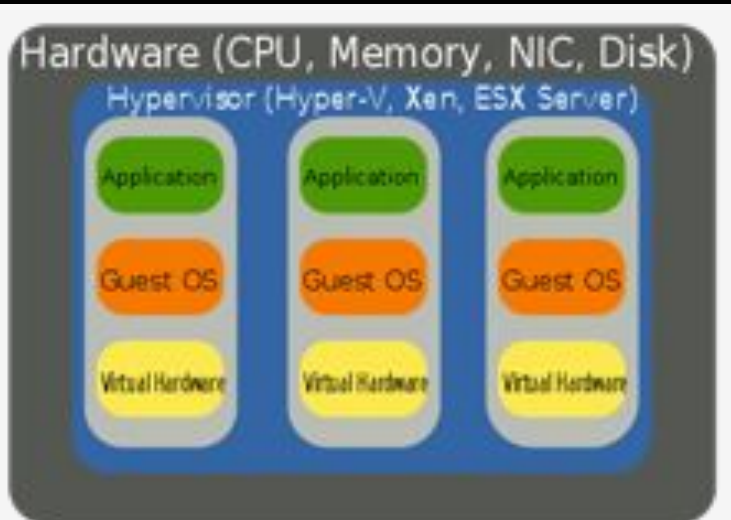

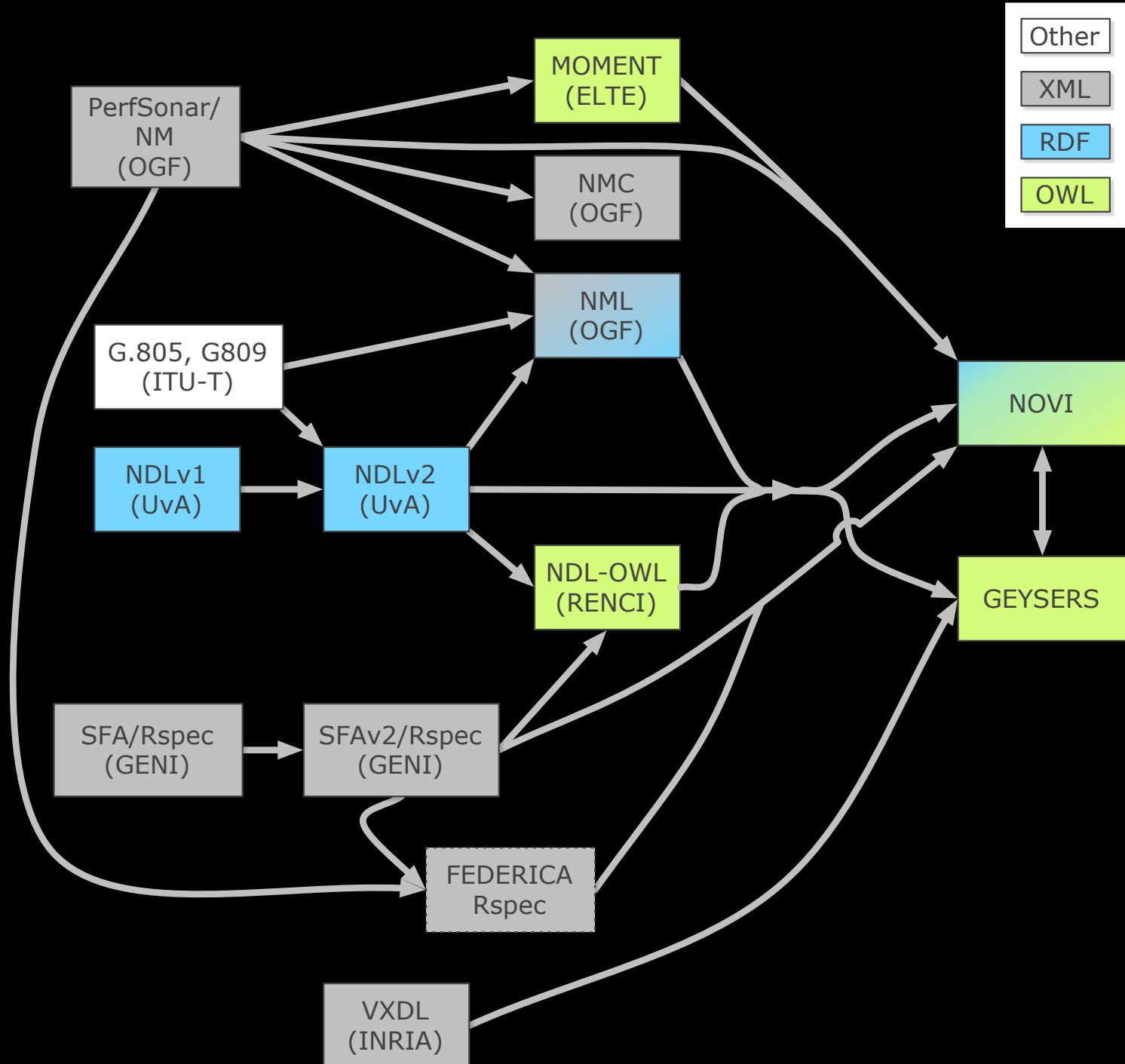

RDF describing Infrastructure

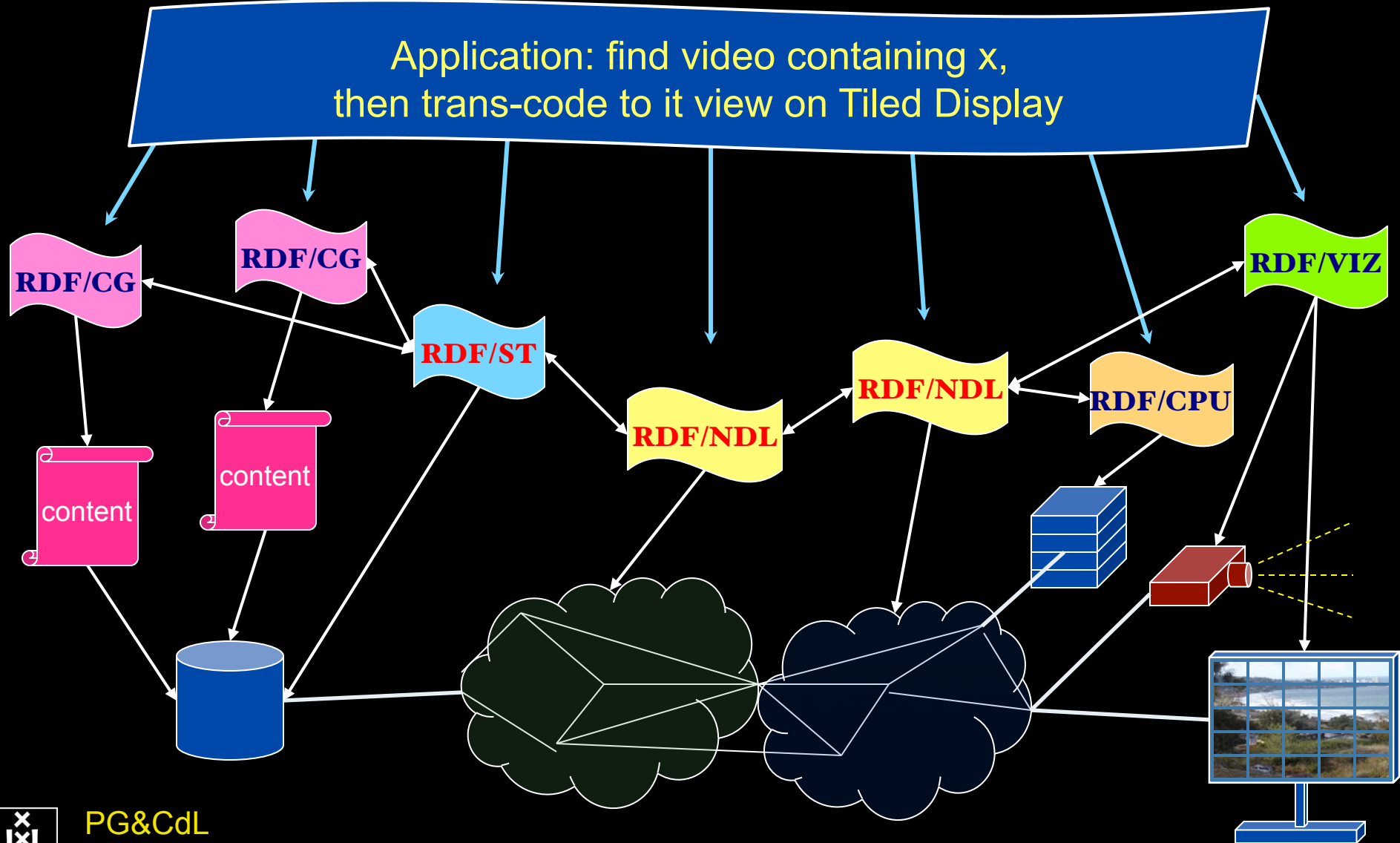

Applications and Networks become aware of each other!

CineGrid Description Language

CineGrid is an initiative to facilitate the exchange, storage and display of high-quality digital media.

The CineGrid Description Language (CDL) describes CineGrid resources. Streaming, display and storage components are organized in a hierarchical way.

CDL has bindings to the NDL ontology that enables descriptions of network components and their interconnections.

With CDL we can reason on the CineGrid infrastructure and its services.

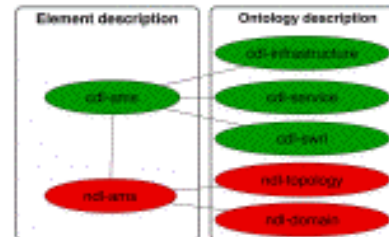

SQWRL is used to query the Ontology.

Which CineGrid nodes are directly connected?



```
cdl:hasElements(?node1, ?host1) ^
ndl:topo:hasInterface(?host1, ?IF1) ^ ndl:
topo:connectedTo(?IF1, ?IF2) ^
ndl:topo:hasInterface(?host2, ?IF2) ^
cdl:hasElements(?node2, ?host2) ->
sqwrl:select(?node1, ?node2)
```

cdl-ams.owl

cdl-ams:Amsterdam cdl-ams:Prague
cdl-ams:Prague cdl-ams:Amsterdam

UML representation of CDL



CDL links to NDL using the **owl:SameAs** property. CDL defines the services, NDL the network interfaces and links. The combination of the two ontologies identifies the host pairs that support matching services via existing network connections.



CineGrid portal

100 Tbyte
Cache & Store & Forward



distribution center Amsterdam

[Home](#) | [About](#) | [Browse Content](#) | [cinegrid.org](#) | [cinegrid.nl](#)

Amsterdam Node Status:

node41:
Disk space used: 8 GiB
Disk space available: 10 GiB

Search node:

Search

Browse by tag:

amsterdam animation
[antonaco](#) blender boat
bridge burna cgi delta holland
hollandfestival
leidschestraat
muziekgebouw
nieuwmarkt opera prague ship
train tram trams waag

100 University van Amsterdam

CineGrid Amsterdam

Welcome to the Amsterdam CineGrid distribution node. Below are the latest additions of super-high-quality video to our node.

For more information about CineGrid and our efforts look at the about section.

Latest Additions

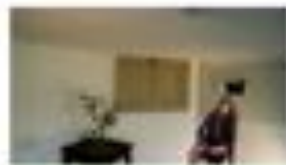

Wypke

Wypke

Available formats:

4k drc (4.8 KB)

Duration: 1 hour and 8 minutes

Created: 1 week, 2 days ago

Author: Wypke

Categories:



Prague Train

Steam locomotive in Prague.

Available formats:

4k drc (3.9 KB)

Duration: 27 hours and 46 minutes

Created: 1 week, 2 days ago

Author: CineGrid

Categories: delta prague train



VLC: Big Buck Bunny

(C) copyright Blender Foundation | <http://www.bigbuckbunny.org>

Available formats:

1080p H264 (1.1 GB)

Duration: 1 hour and 9 minutes

Created: 1 month, 1 week ago

Author: Blender Foundation

Categories: animation blender bunny
cgi

CineGrid Workflow Planner

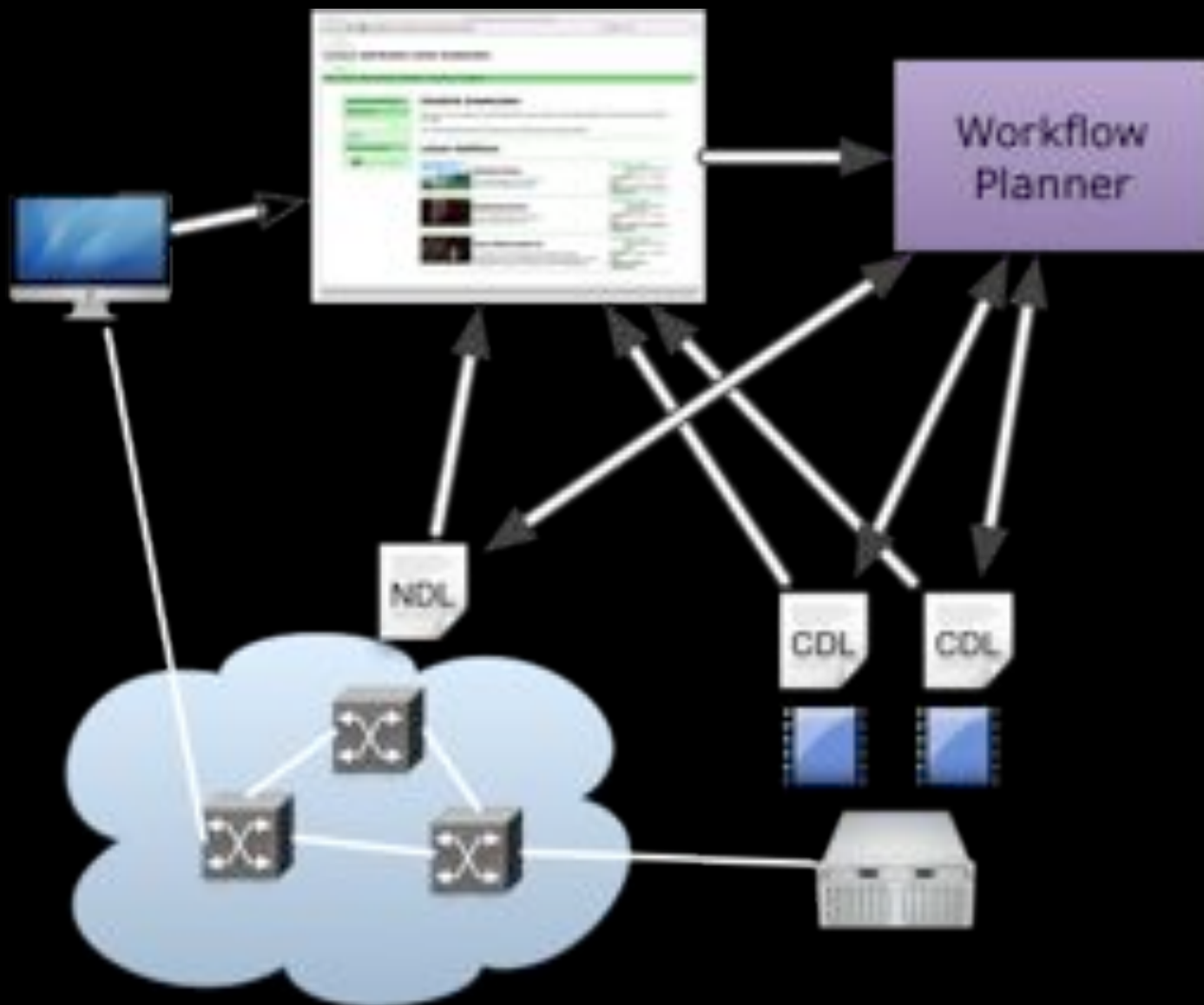

SNE @ UvA

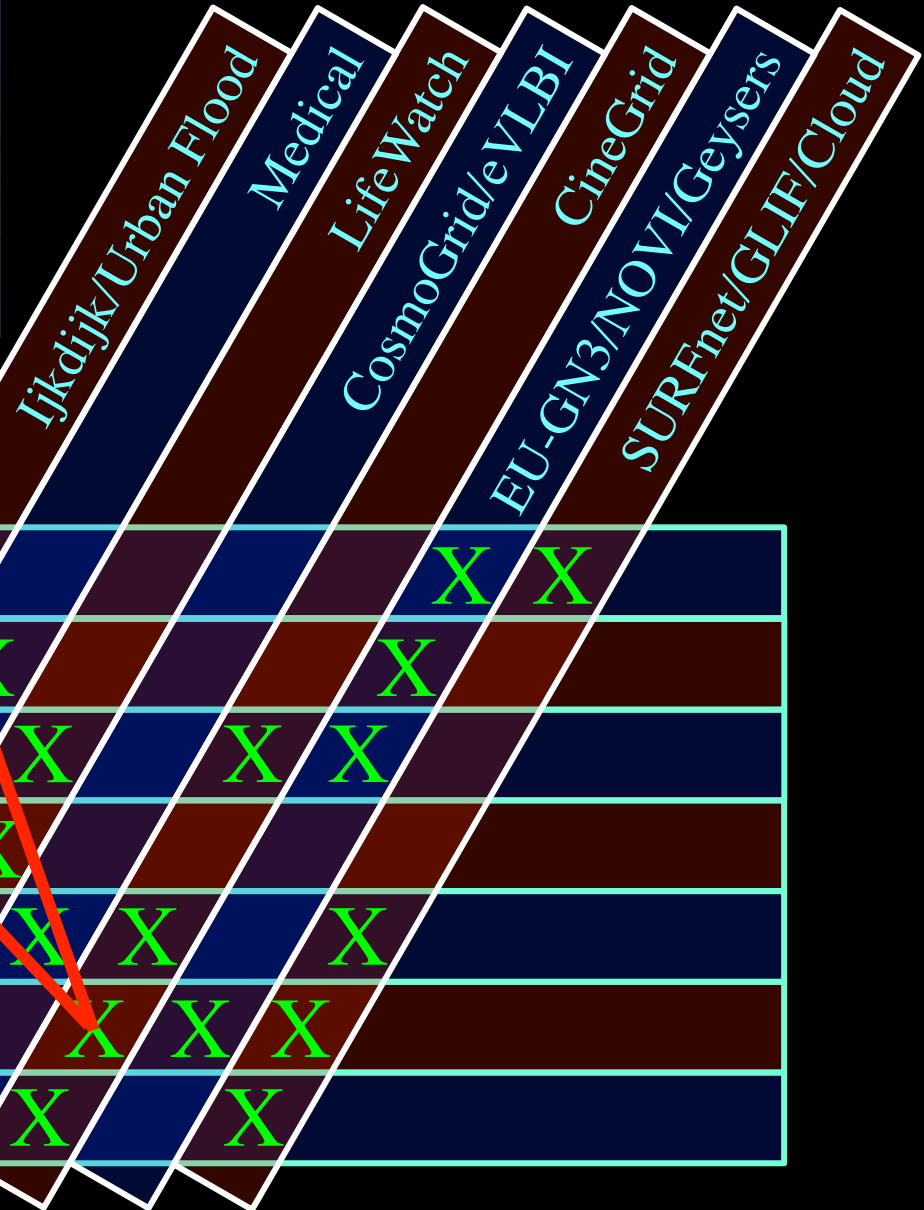

Green-IT

Privacy/Trust

Authorization/policy

Programmable networks

40-100Gig/TCP/WF/QoS

Topology/Architecture

Optical Photonic

X X

X

X

X X

X X

X

X

X X

X X

X

X

X X

X X

X

X

X

X

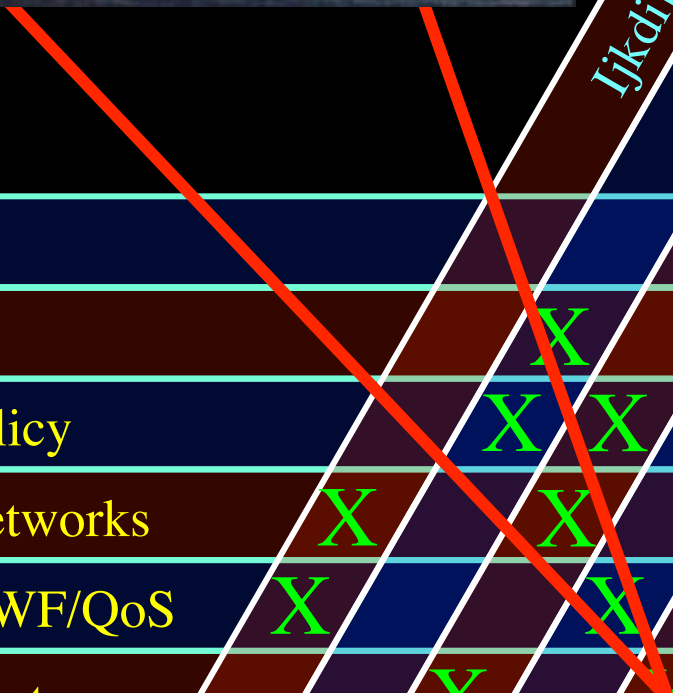

Why is more resolution is better?

1. More Resolution Allows Closer Viewing of Larger Image
2. Closer Viewing of Larger Image Increases Viewing Angle
3. Increased Viewing Angle Produces Stronger Emotional Response

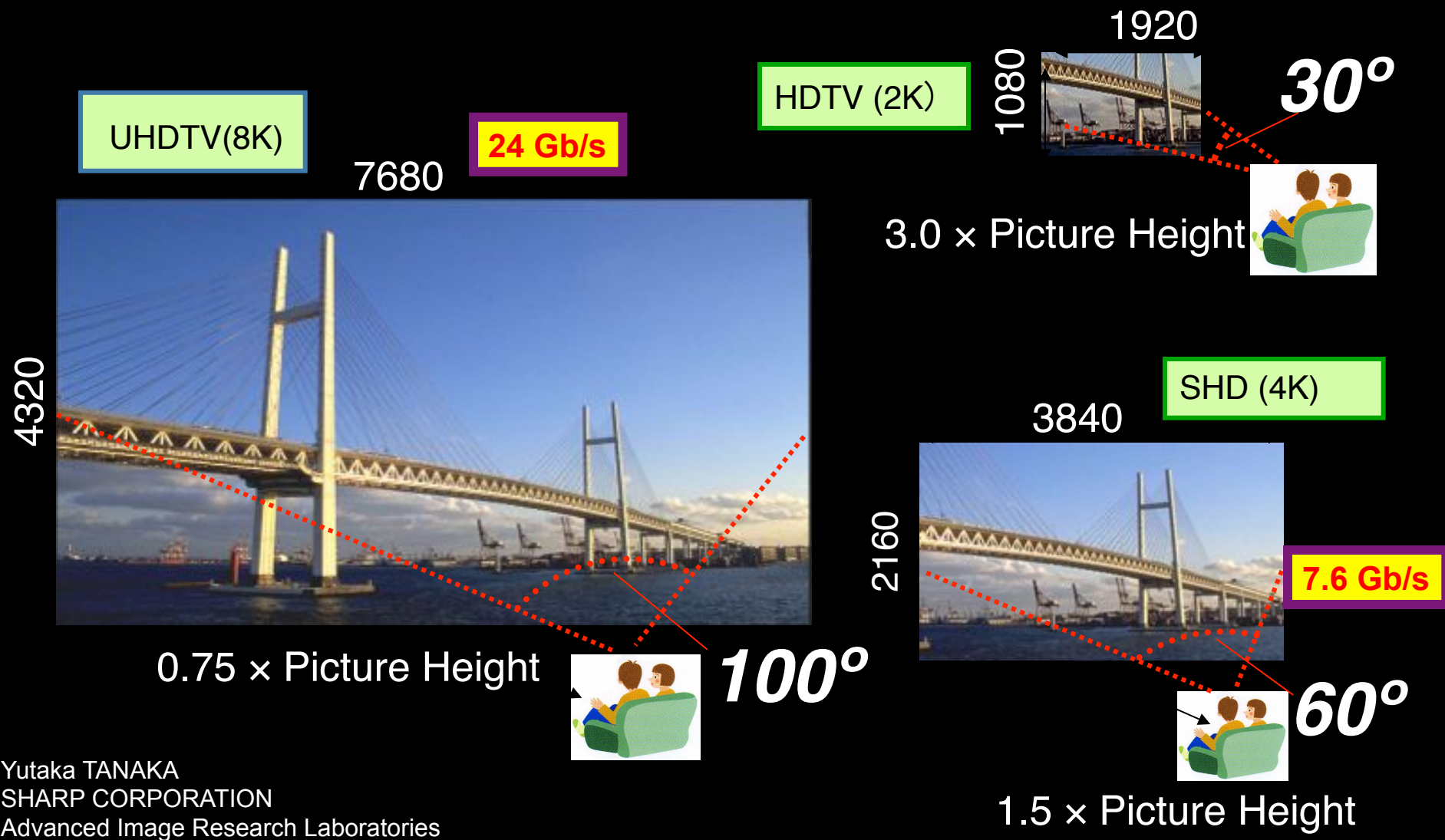



Red End

Robin Noorda & Bethany de Forest

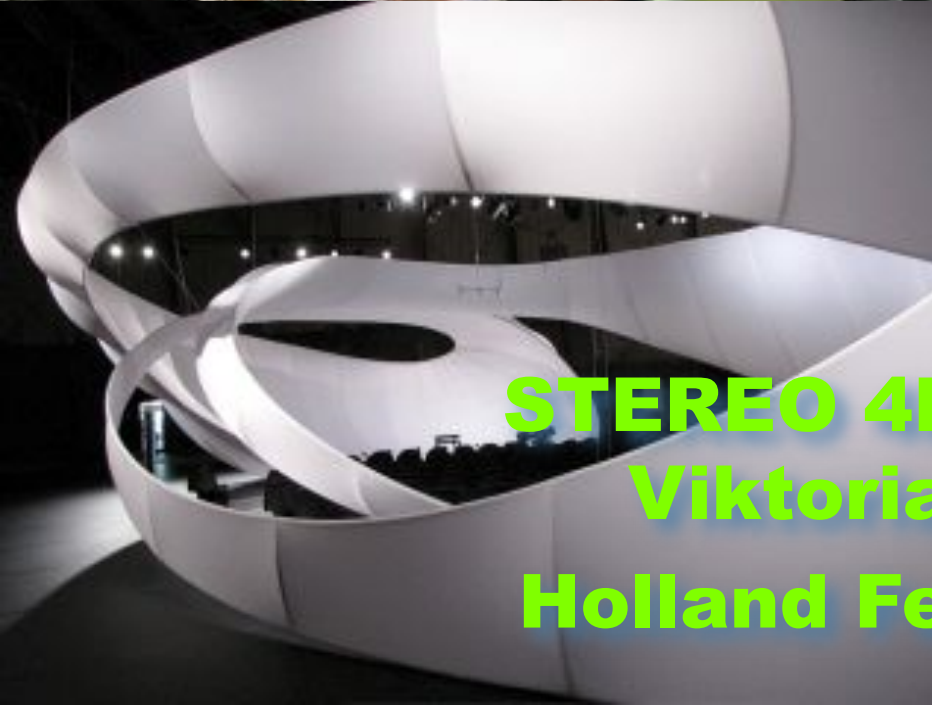

STEREO 4K Recording
Viktoria Mullova
Holland Festival 2010



Hey, not still.



We're almost done. Sshh...



Challenges

- Data – Data – Data
 - Archiving, publication, searchable, transport, self-describing, DB innovations needed, multi disciplinary use
- Virtualisation
 - Another layer of indeterminism
- Greening the Infrastructure
 - e.g. Department Of Less Energy: http://www.ecrinitiative.org/pdfs/ECR_3_0_1.pdf
- Disruptive developments
 - BufferBloath, Revisiting TCP, influence of SSD's & GPU's
 - Multi layer Glif Open Exchange model
 - Invariants in LightPaths (been there done that ☺)
 - X25, ATM, SONET/SDH, Lambda's, MPLS-TE, VLAN's, PBT, OpenFlow,
 - Authorization & Trust & Security and Privacy

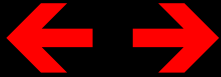

Hybrid Networking <-> Computing

Routers  Supercomputers

Ethernet switches  Grid & Cloud

Photonic transport  GPU's

What matters:

Energy consumption/multiplication

Energy consumption/bit transported

ECO-Scheduling

What type of route should be planned? 8:37am

 Fastest route	 Eco route	 Shortest route
 Avoid motorways	 Walking route	



EU

SARA

SURF-ESRC

Pieken-in-de-Delta

SURFnet

FES

UVA

NWO

NWO-RCF

Q&A

- <http://tnc11.delaat.net>
- <http://ipv6day.nl/> (win an iPad2 !)
- <http://cees.delaat.net/smartgreen/index.html>
- <http://cees.delaat.net/netbuf/index.html>
- <http://cees.delaat.net/ssdtcp/index.html>
- Etc.