

Kwaliteit in een virtuele wereld

Prof. dr. ir. Cees de Laat

Donderdag 27 januari 2011



Virtuele Laboratoria

voor 2000

na 2000

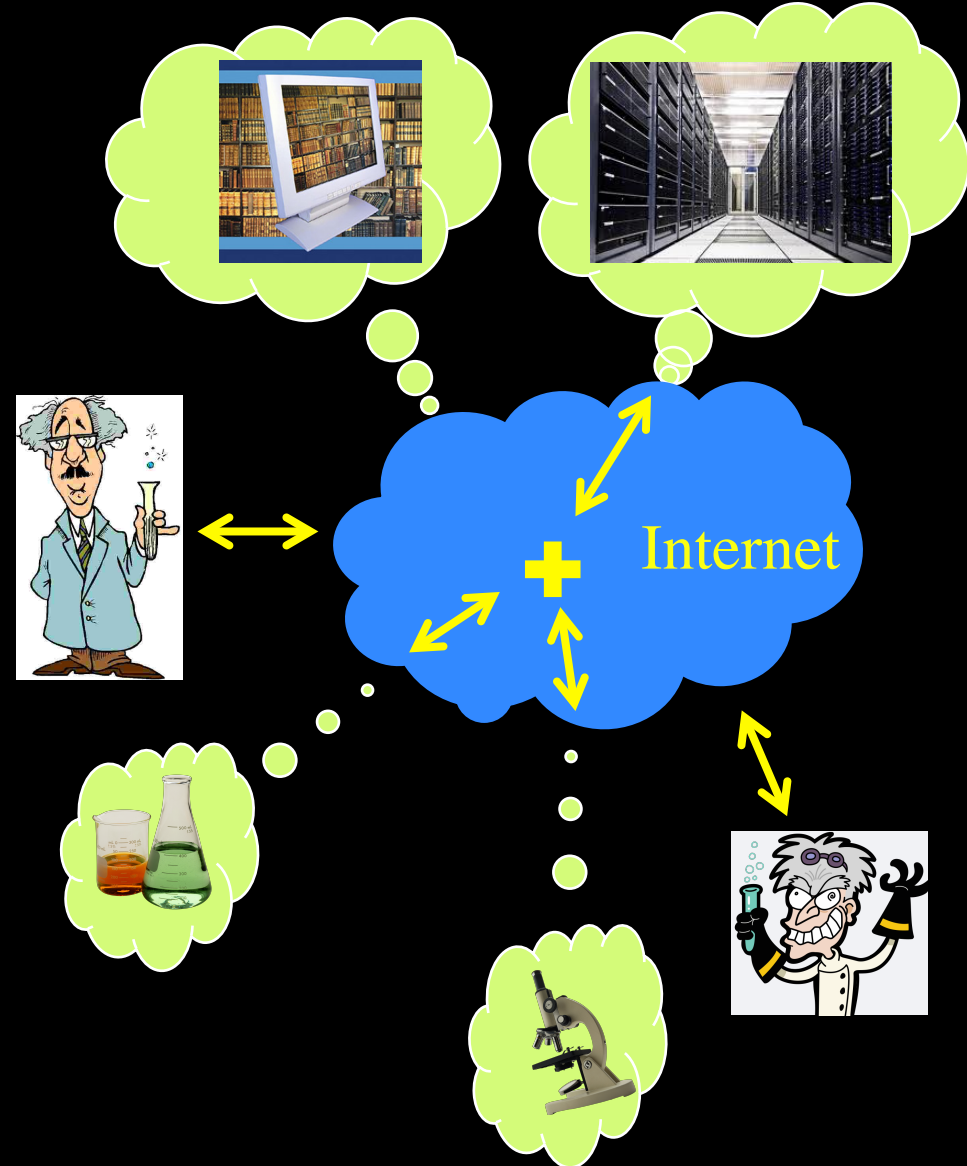
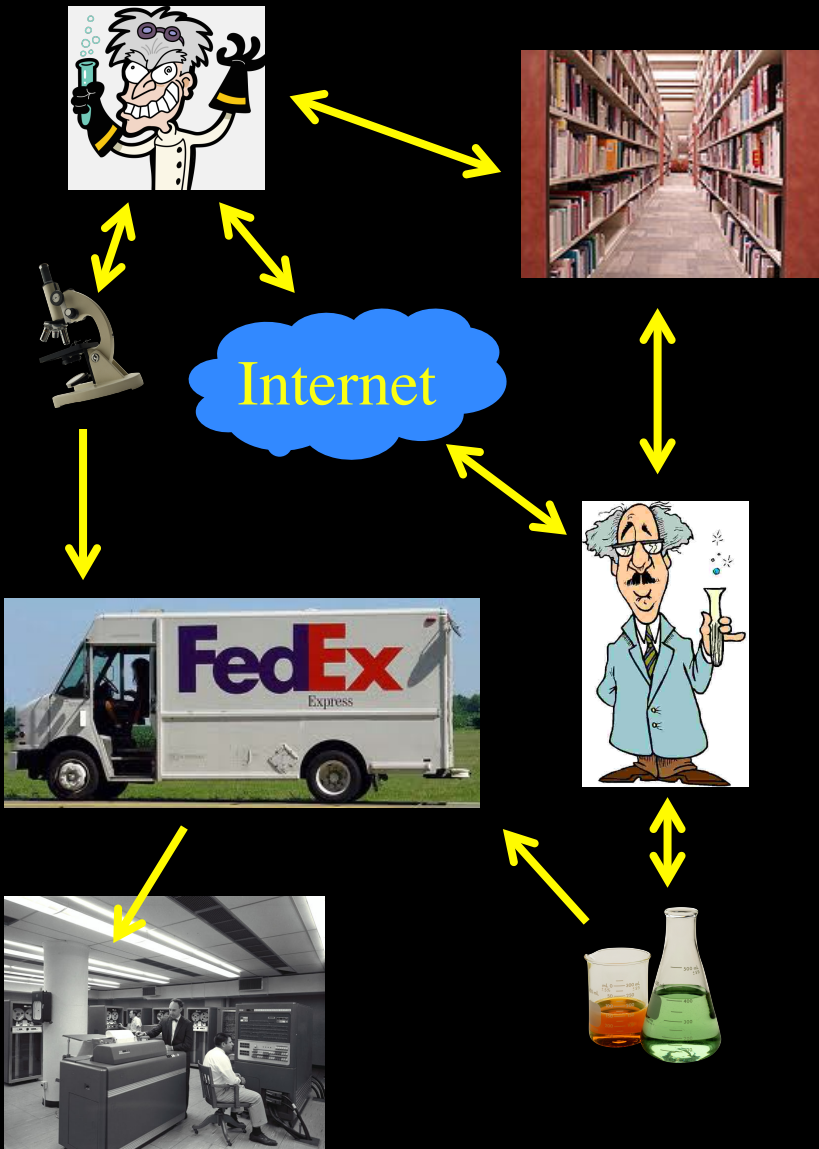

Internet

From a network experiment that never ended (Vint Cerf)

- 1974: for the first time the word **internet** (*RFC 675 - Specification of Internet Transmission Control Program*) [note -> Open process!]
- 1981: the **TCP/IP** standard was ready to be adopted (*RFC 791,792,793*)

To a network for society

- 1989: WWW was born

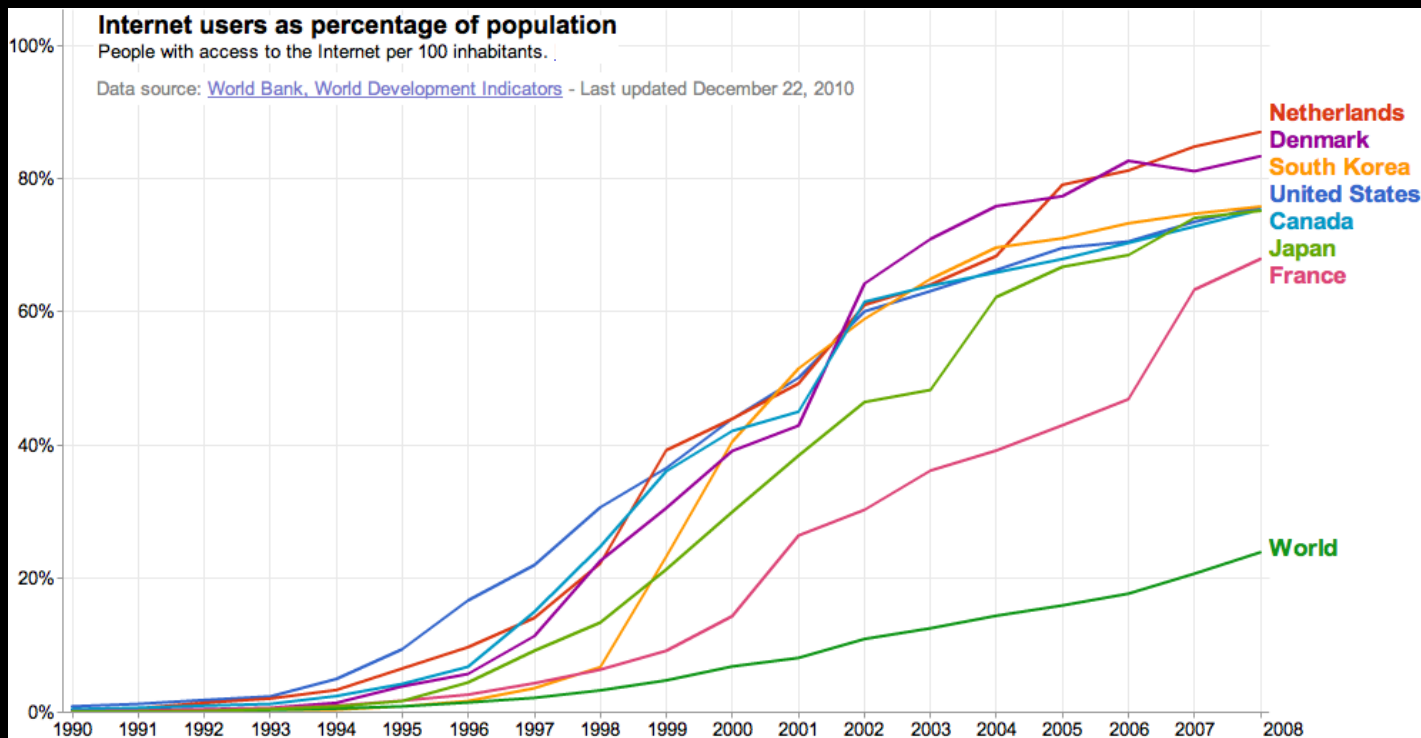

- Jan 2011 → IANA IPv4 address space depleted! →

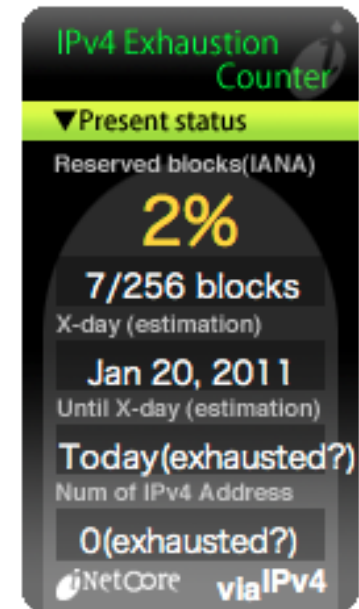

Internet is miljarden business!

Google	197
Amazon	83
Facebook	50
BAIDU	37
eBay	36
Yahoo	22
PriceLine	21
SalesForce	18
F5 Networks	11
CheckPoint	9
NetFlix	9
Expedia	7

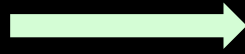

guardian.co.uk Monday 3 January 2011

News | Sport | Comment | Culture | Business | Money | Life & style

News > Technology > Facebook

Facebook's value swells to \$50bn after Goldman Sachs investment

Deal underlines Facebook's power and fuels rumours that Mark Zuckerberg is preparing a stock market flotation

Vgl: Exxon Mobil 368
Apple Inc. 314



1 miljard in 100\$ biljetten

... more data!

Internet ontwikkelingen

Google

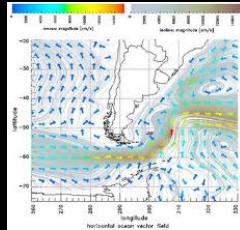

DATA

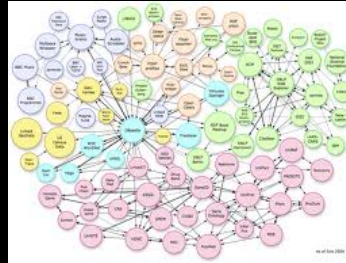

... more realtime!



twitter



myspace
a place for freedom



SchoolBANK

LinkedIn



Hyves

flickr
from YAHOO!



... more users!

Internet ontwikkelingen

... more data!

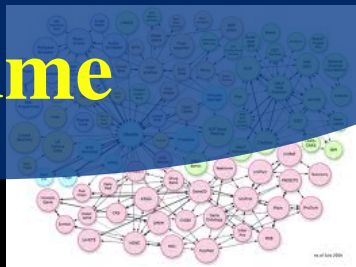
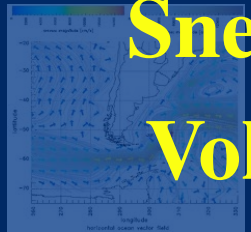
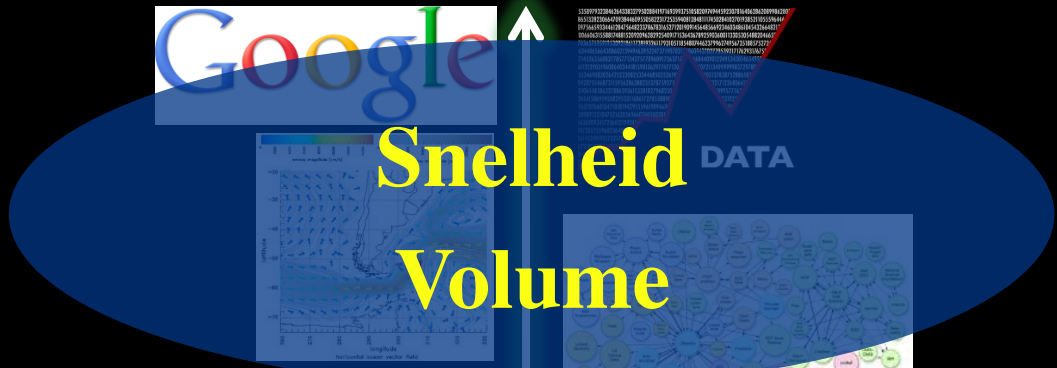

Deterministisch

Real-time realtime!



Schaalbaar

Veiligheid

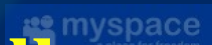

... more users!





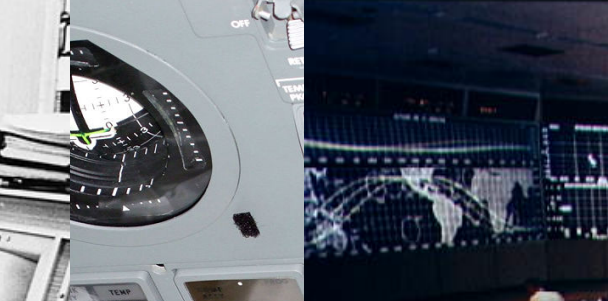

Grafische kaarten disruptieve!

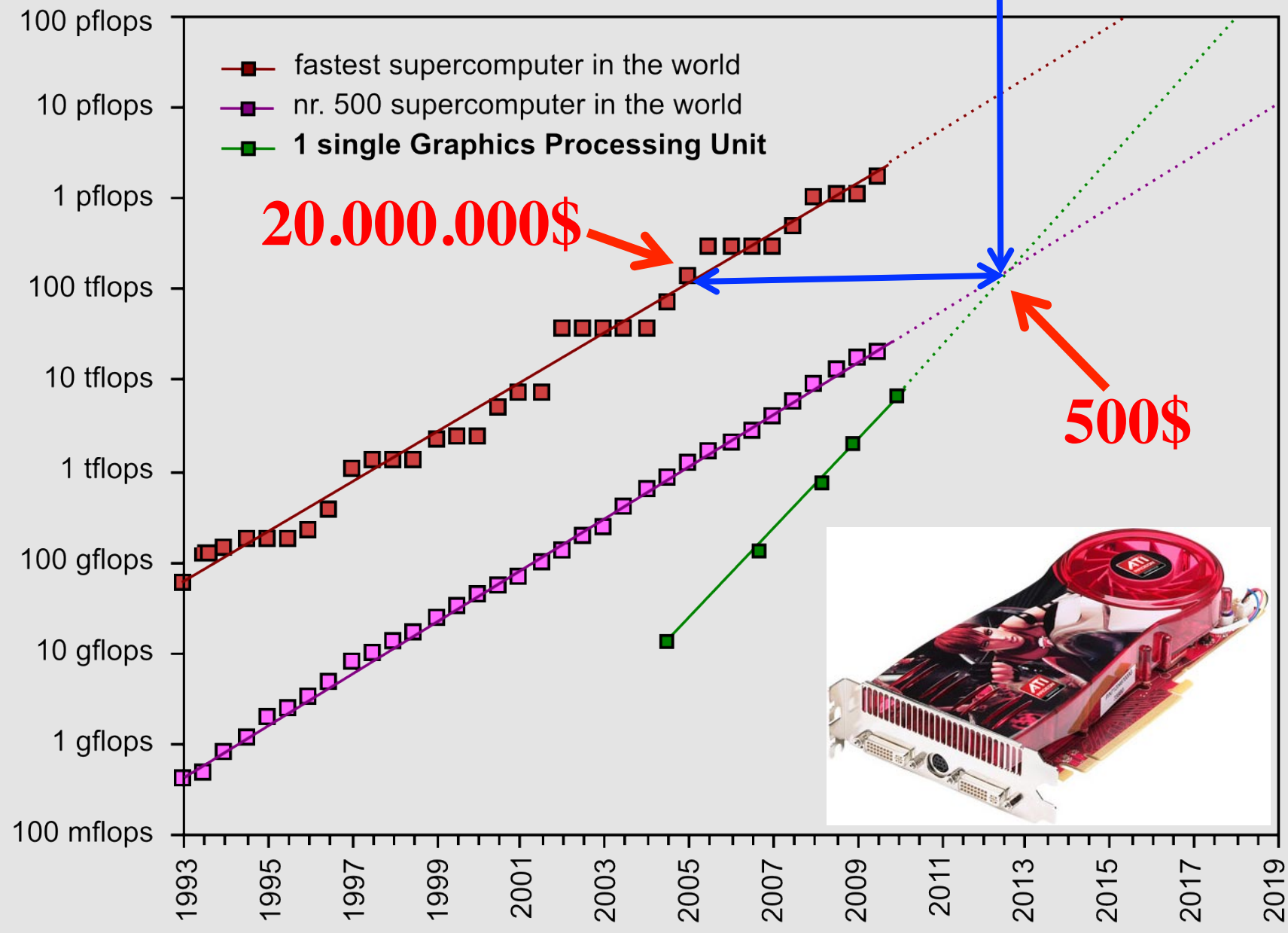

Data opslag: verdubbeling per 1,5 jaar!

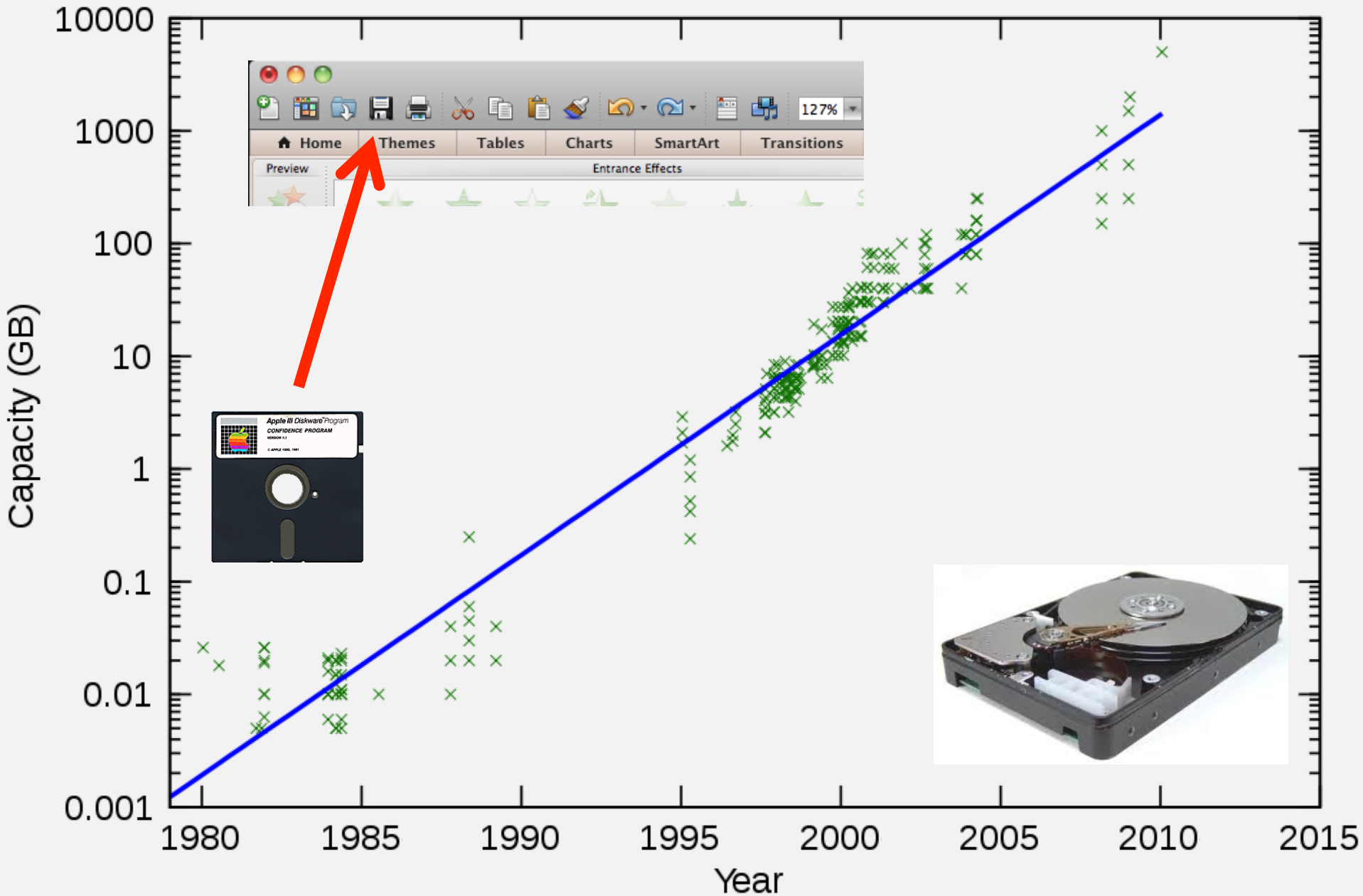

Meerdere kleuren / Fiber

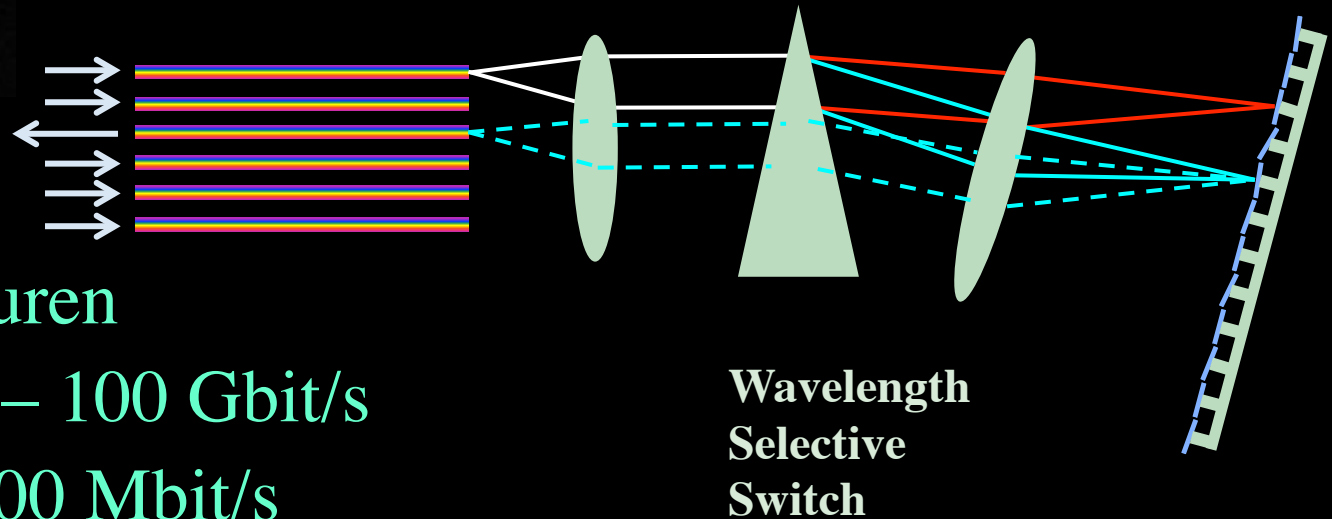
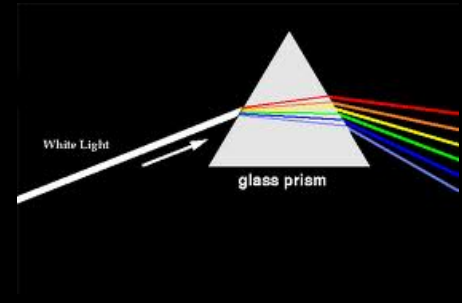
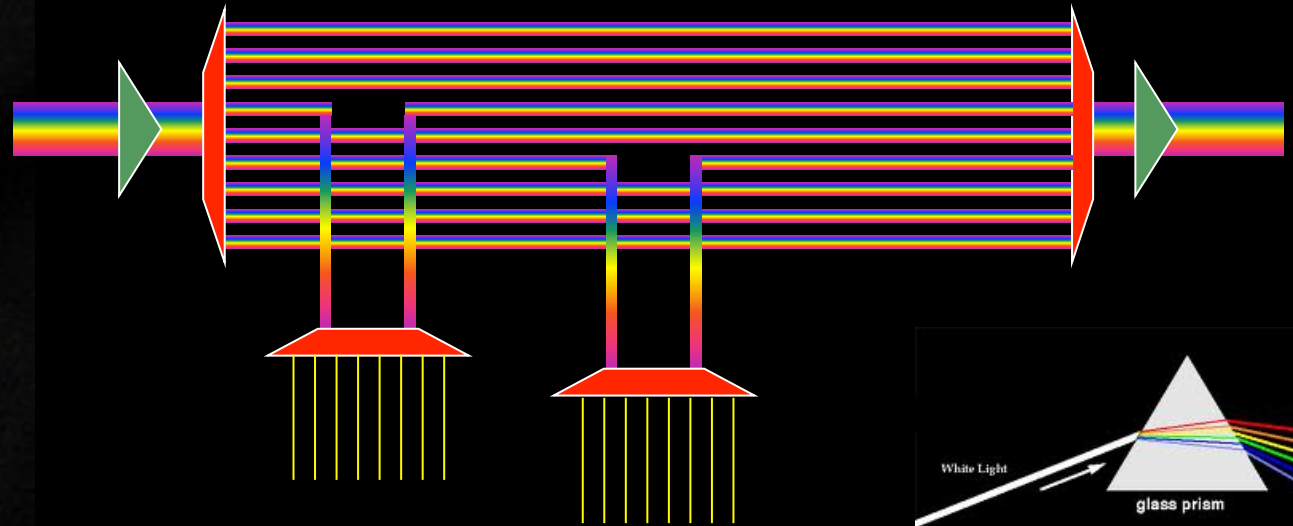

Wavelength
Selective
Switch

Per fiber: ~ 80 kleuren

Per kleur: 10 – 40 – 100 Gbit/s

Vgl: 1 Gbit/s = 1000 Mbit/s

ADSL: ~ 4 – 20 Mbit/s

New: Hollow Fiber!

Draadloze netwerken



Digital technology reviews

Tech XO provided latest Digital Technology reviews like digital camera, digital lens reviews, digital camera

[HOME](#)

[CONTACT US](#)

[PRIVACY POLICY](#)

You Are Here : [Digital Technology Reviews](#) » [Network Devices](#) » Next Generation Wireless LAN Technology 802.11ac 1 Gbps throughput with

SEP
06

Next Generation Wireless LAN Technology 802.11ac 1 Gbps throughput with

Published By [admin](#) under [Network Devices](#) Tags: [1gbps throughput](#), [1gbps wireless](#), [1gbps wireless lans](#), [generation](#), [new generation](#), [technologies](#), [technology](#), [throughput](#), [wireless](#), [wireless lan](#)

WiFi is one of the most preferred communication

protocol LAN due to the easy comparison and convenience in the **digital home**. While consumer PC products has just started to migrate to a much higher bandwidth of 802.11n wireless LAN now working on next-generation standard definition is already in progress.

Draadloze netwerken

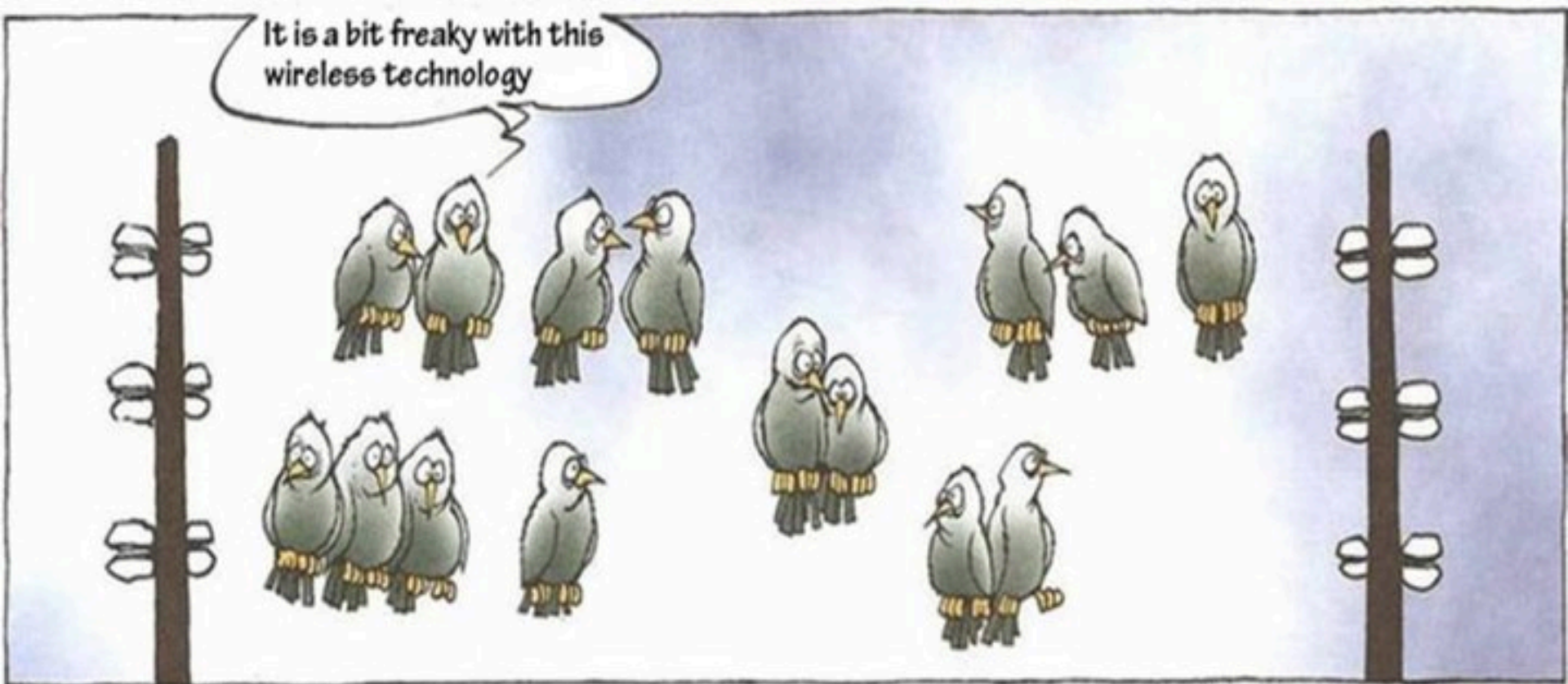

COPYRIGHT : MORTEN INGEMANN

protocol LAN due to the easy comparison and convenience in the **digital home**. While consumer PC products has just started to migrate to a much higher bandwidth of 802.11n wireless LAN now working on next-generation standard definition is already in progress.

SNE @ UvA

Snelheid
Volume

Deterministisch
Real-time

Schaalbaar
Veiligheid

Ijkdijk/Urban Flood

Medical

LifeWatch

CosmoGrid/eVLBI

CineGrid

EU-GN3/NOVI/Geysers

SURFnet/GLIF/Cloud

Green-IT

Privacy/Trust

Authorization/policy

Programmable networks

40-100Gig/TCP/WF/QoS

Topology/Architecture

Optical Photonic

X X

X

X

X X

X X

X

X

X X

X

X

X

X

X

X

X

X

SNE @ UvA

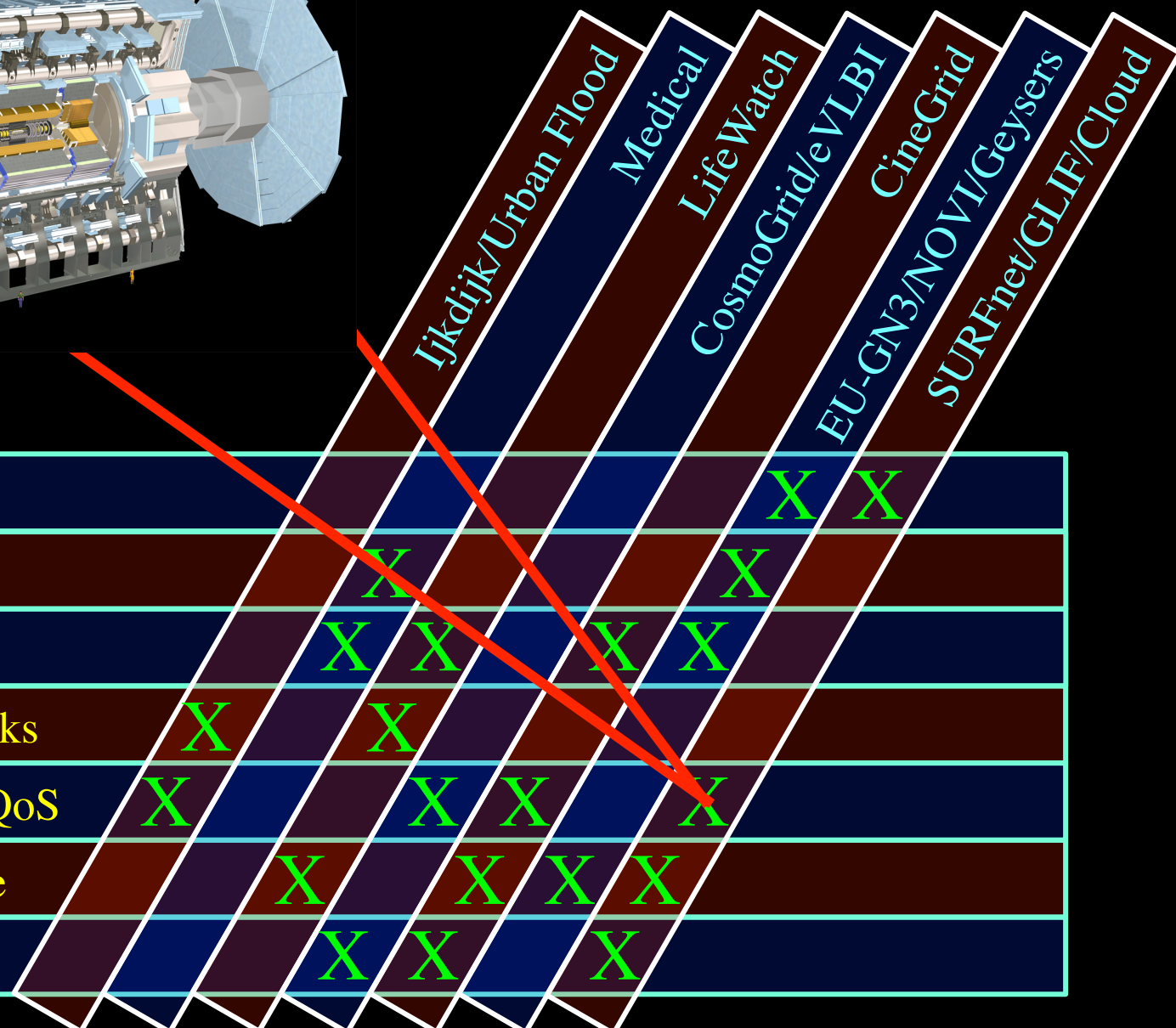
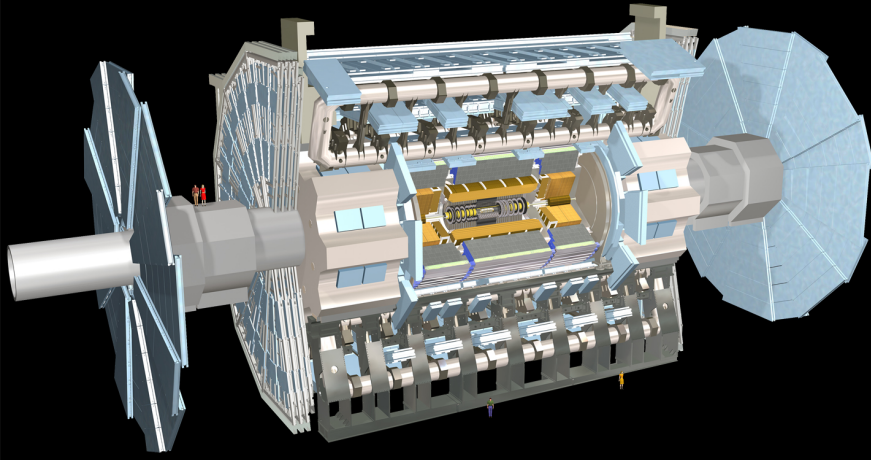

Green-IT					X	X
Privacy/Trust		X			X	
Authorization/policy		X	X	X	X	
Programmable networks	X	X				
40-100Gig/TCP/WF/QoS	X		X	X	X	
Topology/Architecture		X	X	X	X	
Optical Photonic		X	X	X		

ATLAS detector @ CERN Geneve

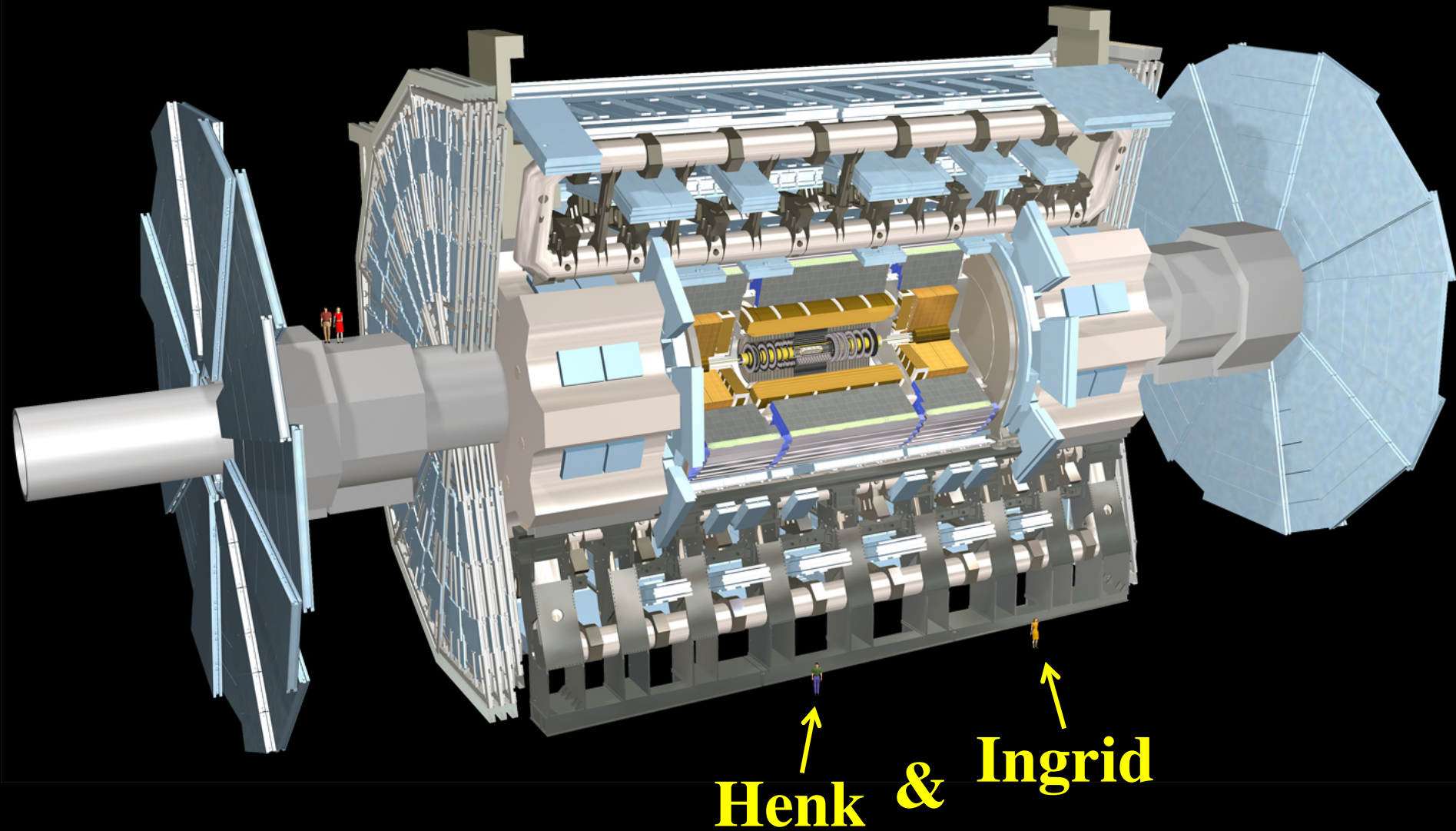

ATLAS detector @ CERN Geneve



Een gebeurtenis

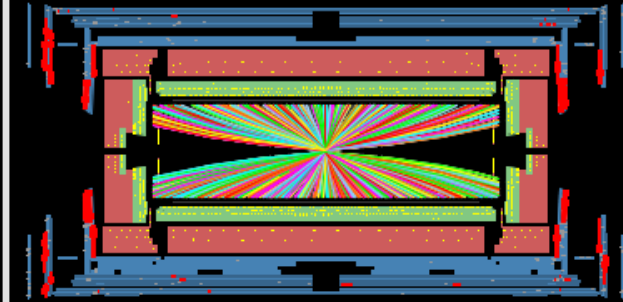
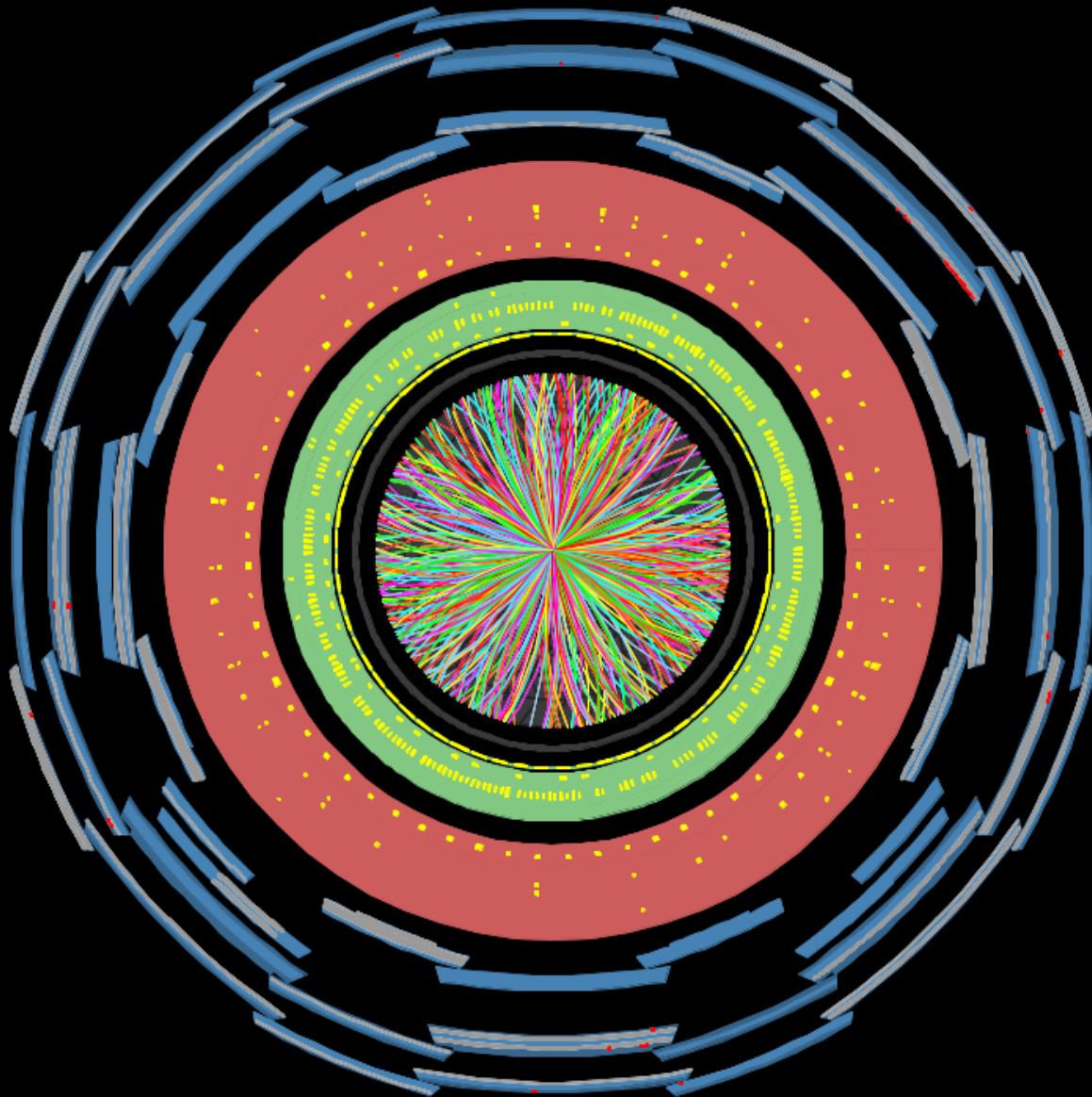

ATLAS
EXPERIMENT

Run Number: 170482, Event Number: 3936308

Date: 2010-12-06 17:21:31 CET

Snapshot of a heavy ion collision
directly from the ATLAS experiment



LHC Data Grid Hierarchy

CMS as example, Atlas is similar

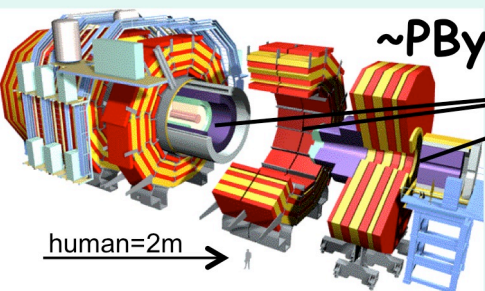
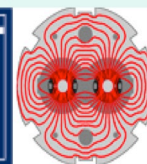

human=2m →

CMS detector: 15m X 15m X 22m
12,500 tons, \$700M.

Online System

Tier 0 + 1

~100 MBytes/sec

100000 flops/byte

10 Pflops/s

event simulation

event reconstruction

~2.5 Gbits/sec

Tier 1

Italian Regional Center

German Regional Center

NIKHEF Dutch Regional Center

FermiLab, USA Regional Center

analysis

~0.6-2.5 Gbps

Tier 2 Center

Tier 2

Tier 3

~0.6-2.5 Gbps

Institute ~0.25TIPS

CERN/CMS data goes to 6-8 Tier 1 regional centers, and from each of these to 6-10 Tier 2 centers.

Physicists work on analysis "channels" at 135 institutes. Each institute has ~10 physicists working on one or more channels.

2000 physicists in 31 countries are involved in this 20-year experiment in which DOE is a major player.

Physics data cache

100 - 1000 Mbits/sec

Tier 4



Workstations

Grote en kleine pakketten door elkaar





Diagram for SAGE video streaming to ATS

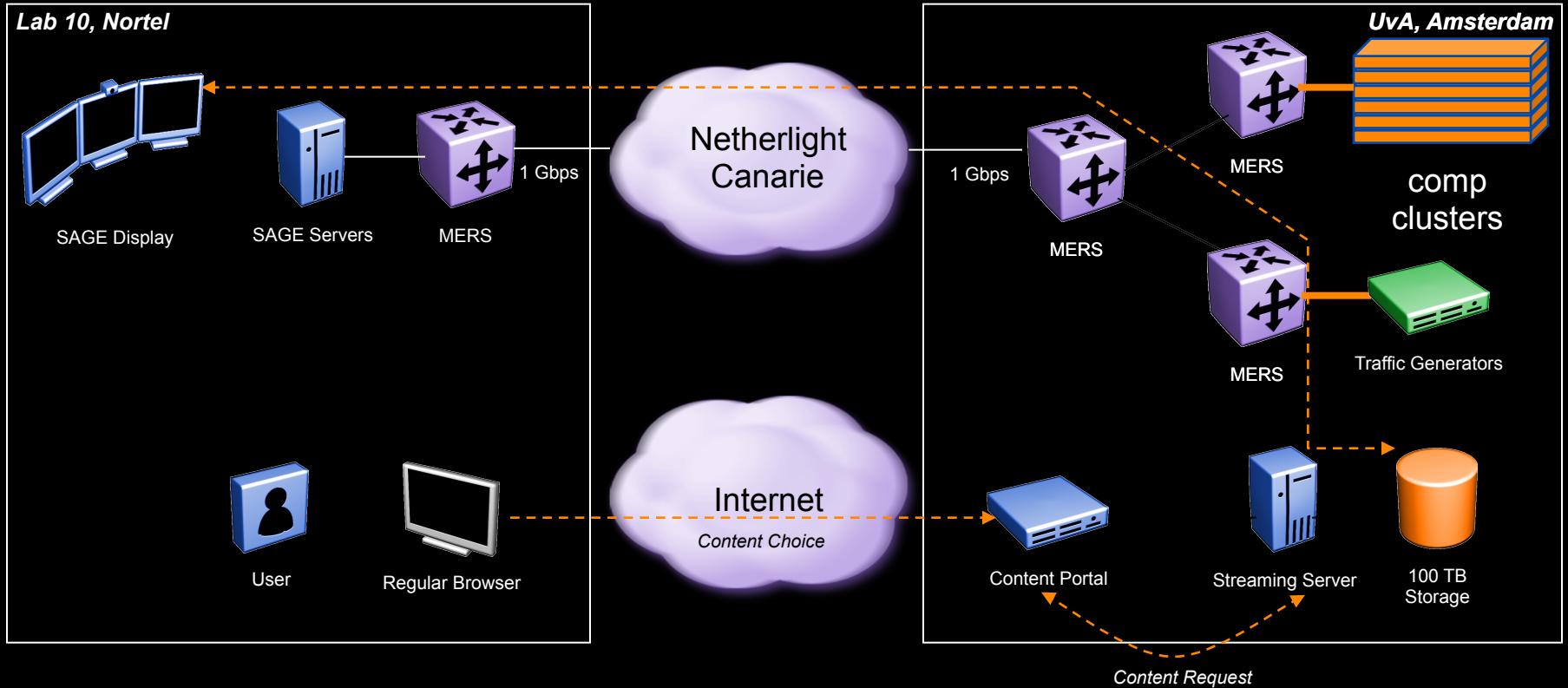

Experimental Data



Sage without background traffic

Sage with background traffic

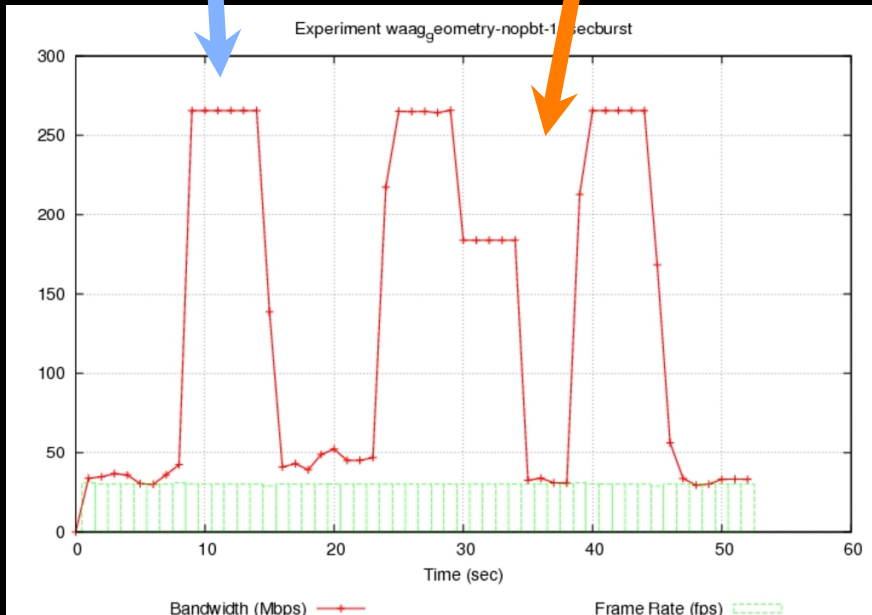

10 Second Traffic bursts with No PBT

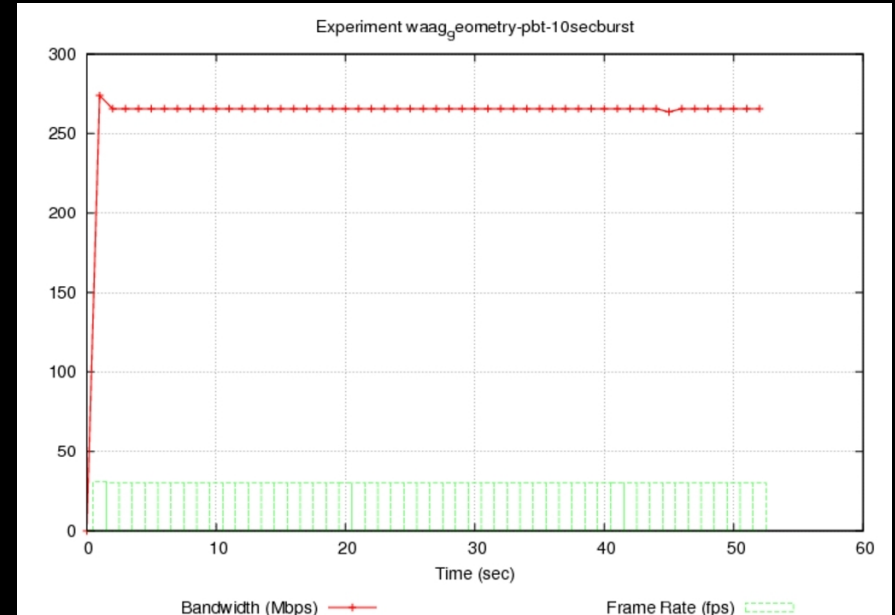

10 Second Traffic bursts with PBT

PBT is SIMPLE and EFFECTIVE technology to build a shared Media-Ready Network



Alien light From idea to realisation!

40Gb/s alien wavelength transmission via a multi-vendor 10Gb/s DWDM infrastructure



Alien wavelength advantages

- Direct connection of customer equipment^[1] → cost savings
- Avoid OEO regeneration → power savings
- Faster time to service^[2] → time savings
- Support of different modulation formats^[3] → extend network lifetime

Alien wavelength challenges

- Complex end-to-end optical path engineering in terms of linear (i.e. OSNR, dispersion) and non-linear (FWM, SPM, XPM, Raman) transmission effects for different modulation formats.
- Complex interoperability testing.
- End-to-end monitoring, fault isolation and resolution.
- End-to-end service activation.

In this demonstration we will investigate the performance of a 40Gb/s PM-QPSK alien wavelength installed on a 10Gb/s DWDM infrastructure.

New method to present fiber link quality, FoM (Figure of Merit)

In order to quantify optical link grade, we propose a new method of representing system quality: the FOM (Figure of Merit) for concatenated fiber spans.

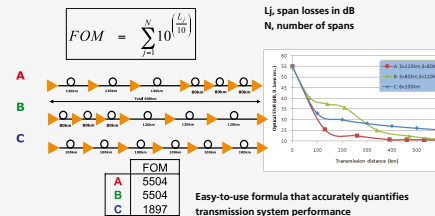

Transmission system setup

JOINT SURFnet/NORDUnet 40Gb/s PM-QPSK alien wavelength DEMONSTRATION.

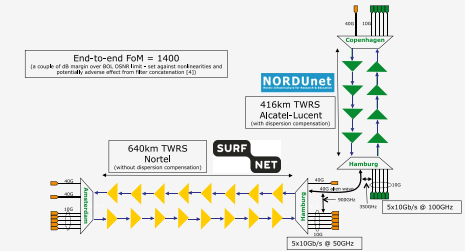

Test results

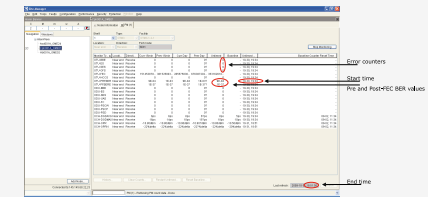

Error-free transmission for 23 hours, 17 minutes → BER < 3,0 · 10⁻¹⁶

Conclusions

- We have investigated experimentally the all-optical transmission of a 40Gb/s PM-QPSK alien wavelength via a concatenated native and third party DWDM system that both were carrying live 10Gb/s wavelengths.
- The end-to-end transmission system consisted of 1056 km of TWRS (TrueWave Reduced Slope) transmission fiber.
- We demonstrated error-free transmission (i.e. BER below 10⁻¹⁵) during a 23 hour period.
- More detailed system performance analysis will be presented in an upcoming paper.



REFERENCES
ACKNOWLEDGEMENTS

[1] "OPERATIONAL SOLUTIONS FOR AN OPEN DWDM LAYER", O. GERSTEL ET AL. OFC2009 | [2] "AT&T OPTICAL TRANSPORT SERVICES", BARBARA E. SMITH, OFC'09
 [3] "OPEX SAVINGS OF ALL-OPTICAL CORE NETWORKS", ANDREW LORD AND CARL ENGINEER, ECCO2009 | [4] NORTEL/SURFNET INTERNAL COMMUNICATION
 WE ARE GRATEFUL TO NORDUNET FOR PROVIDING US WITH BANDWIDTH ON THEIR DWDM LINK FOR THIS EXPERIMENT AND ALSO FOR THEIR SUPPORT AND ASSISTANCE DURING THE EXPERIMENTS. WE ALSO ACKNOWLEDGE TELINUS AND NORTEL FOR THEIR INTEGRATION WORK AND SIMULATION SUPPORT

Alien light From idea to realisation!

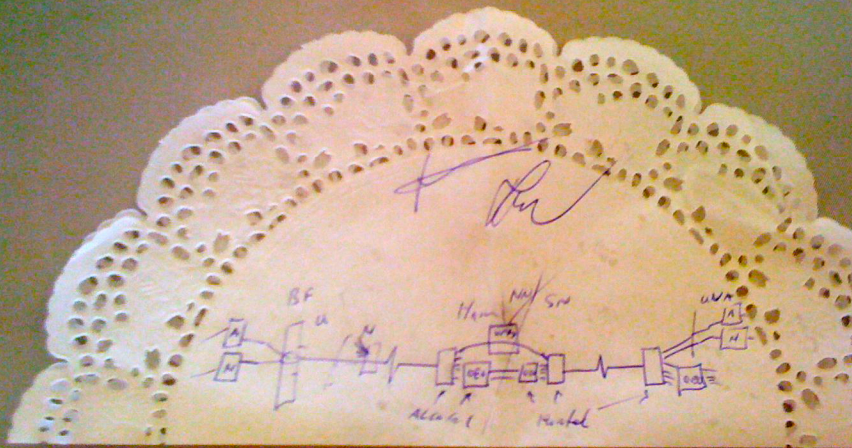

40Gb/s alien wavelength transmission via a multi-vendor 10Gb/s DWDM infrastructure



Alien wavelength advantages

- Direct connection of customer equipment^[1] → cost savings
- Avoid OEO regeneration → power savings
- Faster time to service^[2] → time savings
- Support of different modulation formats^[3] → extend network lifetime

Alien wavelength challenges

- Complex end-to-end optical path engineering in terms of linear (i.e. OSNR, dispersion) and non-linear (FWM, SPM, XPM, Raman) transmission effects for different modulation formats.
- Complex interoperability testing.
- End-to-end monitoring, fault isolation and resolution.
- End-to-end service activation.

In this demonstration we will investigate the performance of a 40Gb/s PM-QPSK alien wavelength installed on a 10Gb/s DWDM infrastructure.

New method to present fiber link quality, FoM (Figure of Merit)

In order to quantify optical link grade, we propose a new method of representing system quality: the FOM (Figure of Merit) for concatenated fiber spans.

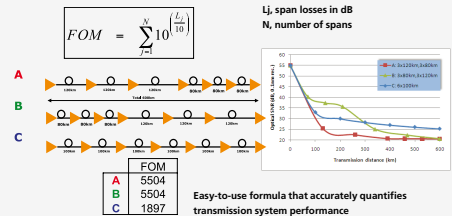

Transmission system setup

JOINT SURFnet/NORDUnet 40Gb/s PM-QPSK alien wavelength DEMONSTRATION.

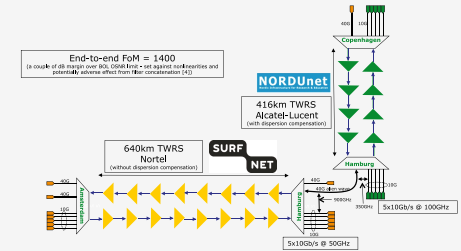

Test results

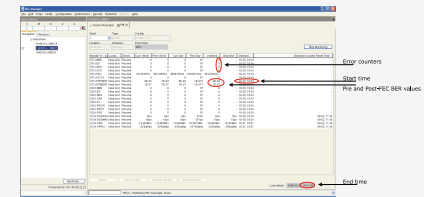

Error-free transmission for 23 hours, 17 minutes → BER < 3.0 10⁻¹⁶

Conclusions

- We have investigated experimentally the all-optical transmission of a 40Gb/s PM-QPSK alien wavelength via a concatenated native and third party DWDM system that both were carrying live 10Gb/s wavelengths.
- The end-to-end transmission system consisted of 1056 km of TWRS (TrueWave Reduced Slope) transmission fiber.
- We demonstrated error-free transmission (i.e. BER below 10⁻¹⁵) during a 23 hour period.
- More detailed system performance analysis will be presented in an upcoming paper.



REFERENCES
ACKNOWLEDGEMENTS

[1] "OPERATIONAL SOLUTIONS FOR AN OPEN DWDM LAYER", O. GERSTEL ET AL. OFC2009 | [2] "AT&T OPTICAL TRANSPORT SERVICES", BARBARA E. SMITH, OFC'09
[3] "OPEX SAVINGS OF ALL-OPTICAL CORE NETWORKS", ANDREW LORD AND CARL ENGINEER, ECCO2009 | [4] NORTEL/SURFNET INTERNAL COMMUNICATION
WE ARE GRATEFUL TO NORDUNET FOR PROVIDING US WITH BANDWIDTH ON THEIR DWDM LINK FOR THIS EXPERIMENT AND ALSO FOR THEIR SUPPORT AND ASSISTANCE DURING THE EXPERIMENTS. WE ALSO ACKNOWLEDGE TELINDUS AND NORTEL FOR THEIR INTEGRATION WORK AND SIMULATION SUPPORT

SNE @ UvA

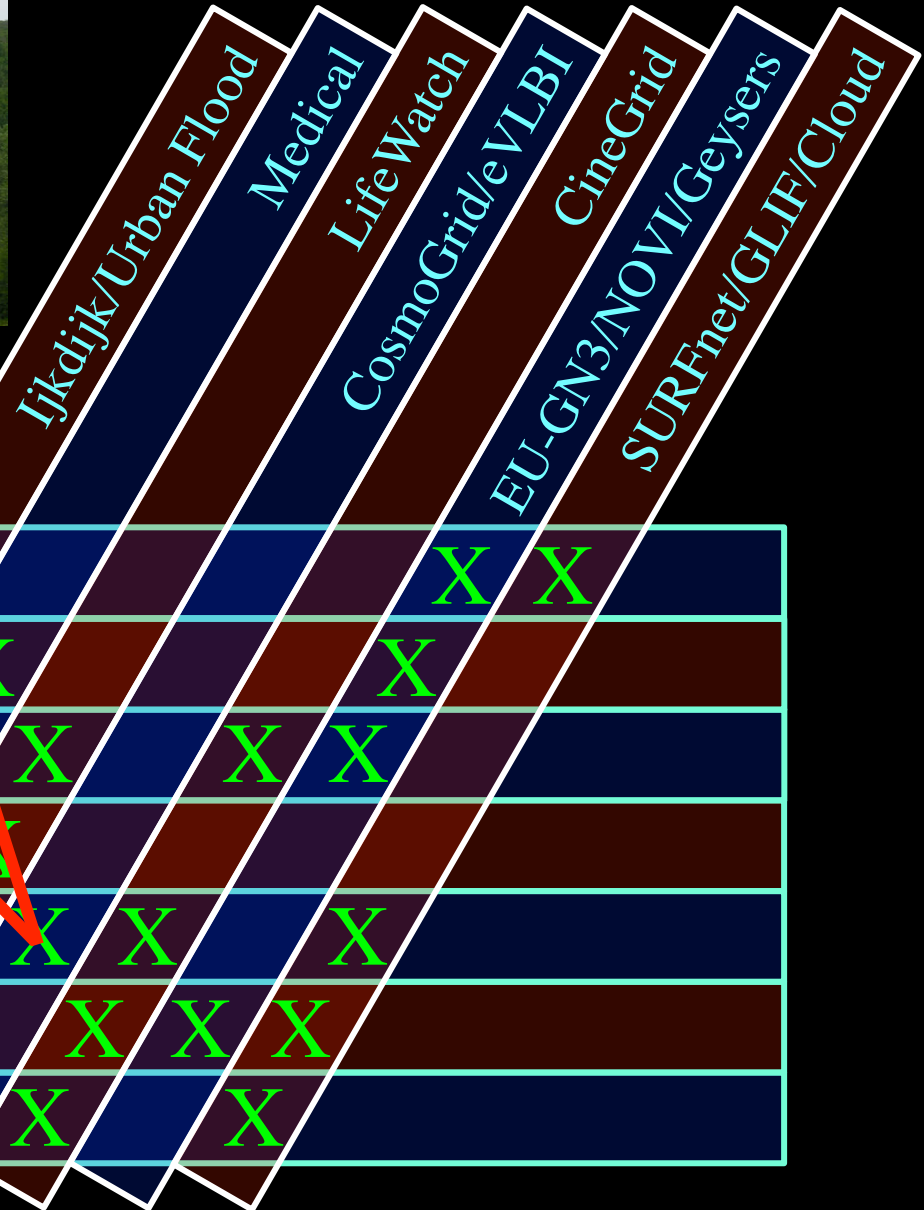

Green-IT

Privacy/Trust

Authorization/policy

Programmable networks

40-100Gig/TCP/WF/QoS

Topology/Architecture

Optical Photonic

				X	X	
		X			X	
	X	X		X	X	
X		X				
X	X		X	X	X	
	X	X	X	X		
	X	X		X		

e - Very Large Base Interferometer

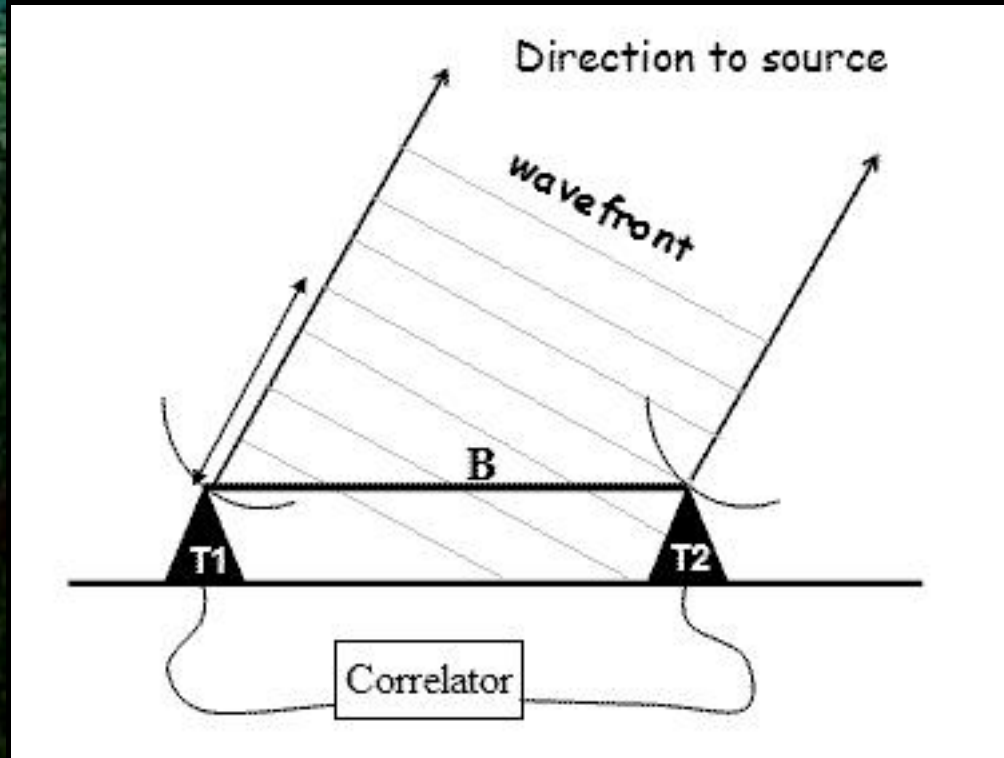

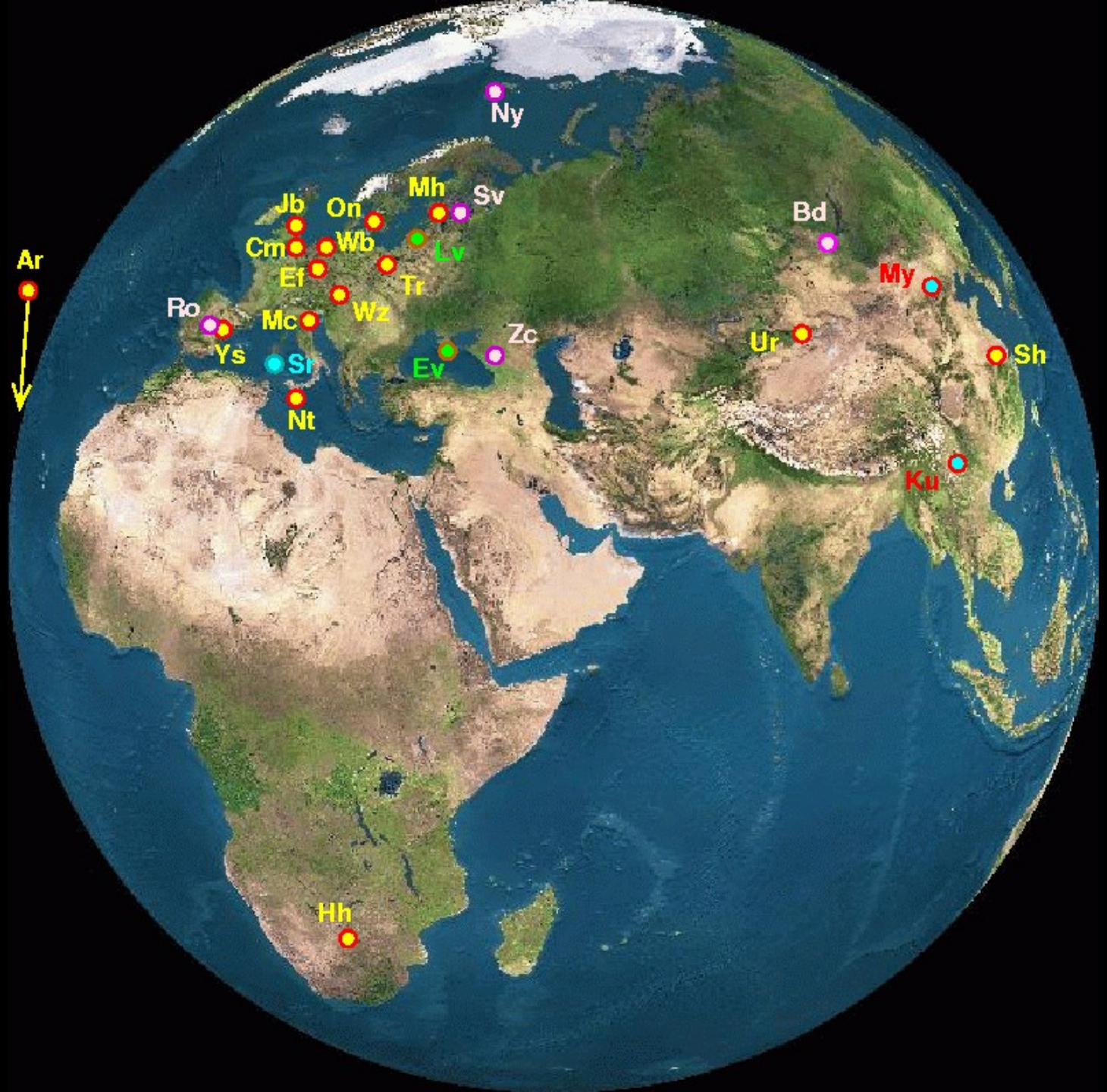

2008

2009

Deadline for submitting observing proposals

Program committee:
* rates proposals
* allocates observing time

VLBI Observing Session

Disks shipped to JIVE

Correlation at JIVE

Data shipped

Data arrives at
at scientist's desk!

Sep | Oct | Nov | Dec | Jan | Feb | Mar | Apr | May | Jun |

2008

2009



eEVN: European VLBI Network

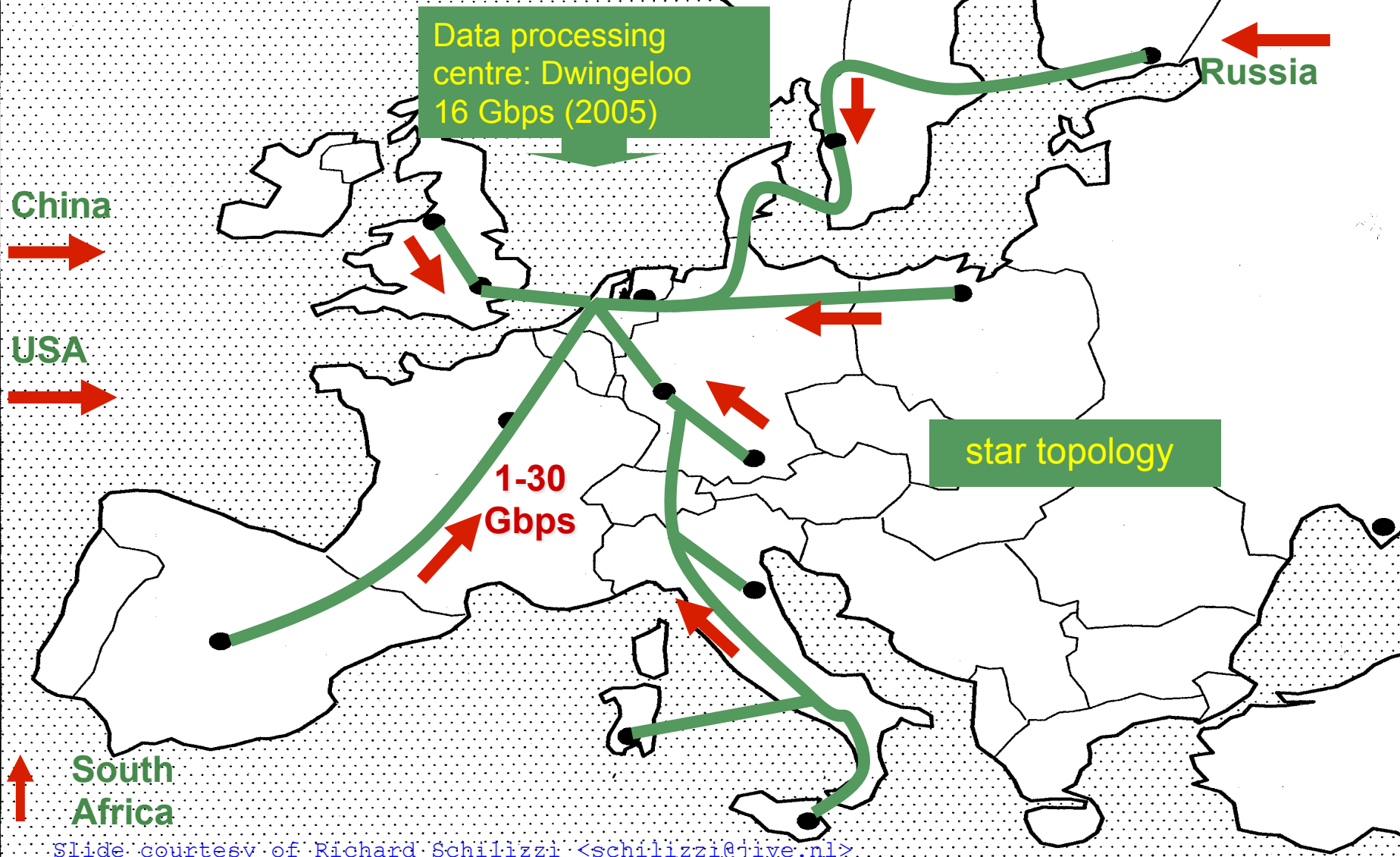

Slide courtesy of Richard Schilizzi <schilizzi@jive.nl>

eVLBI: European VLBI Network

Dec 4

Dec 5

Dec 6

Deadline for submitting eVLBI observing proposals

Program committee decides if eVLBI science can be justified



eVLBI Observing Run

Correlation at JIVE

Scientist downloads data from www.jive.nl

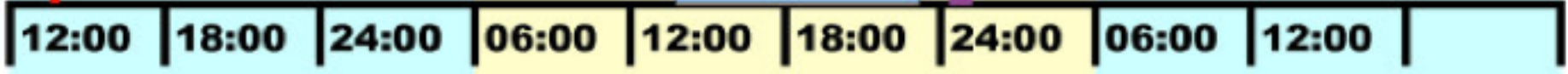

The SCARIE project

SCARIE: a research project to create a Software Correlator for e-VLBI.
VLBI Correlation: signal processing technique to get high precision image from spatially distributed radio-telescope.

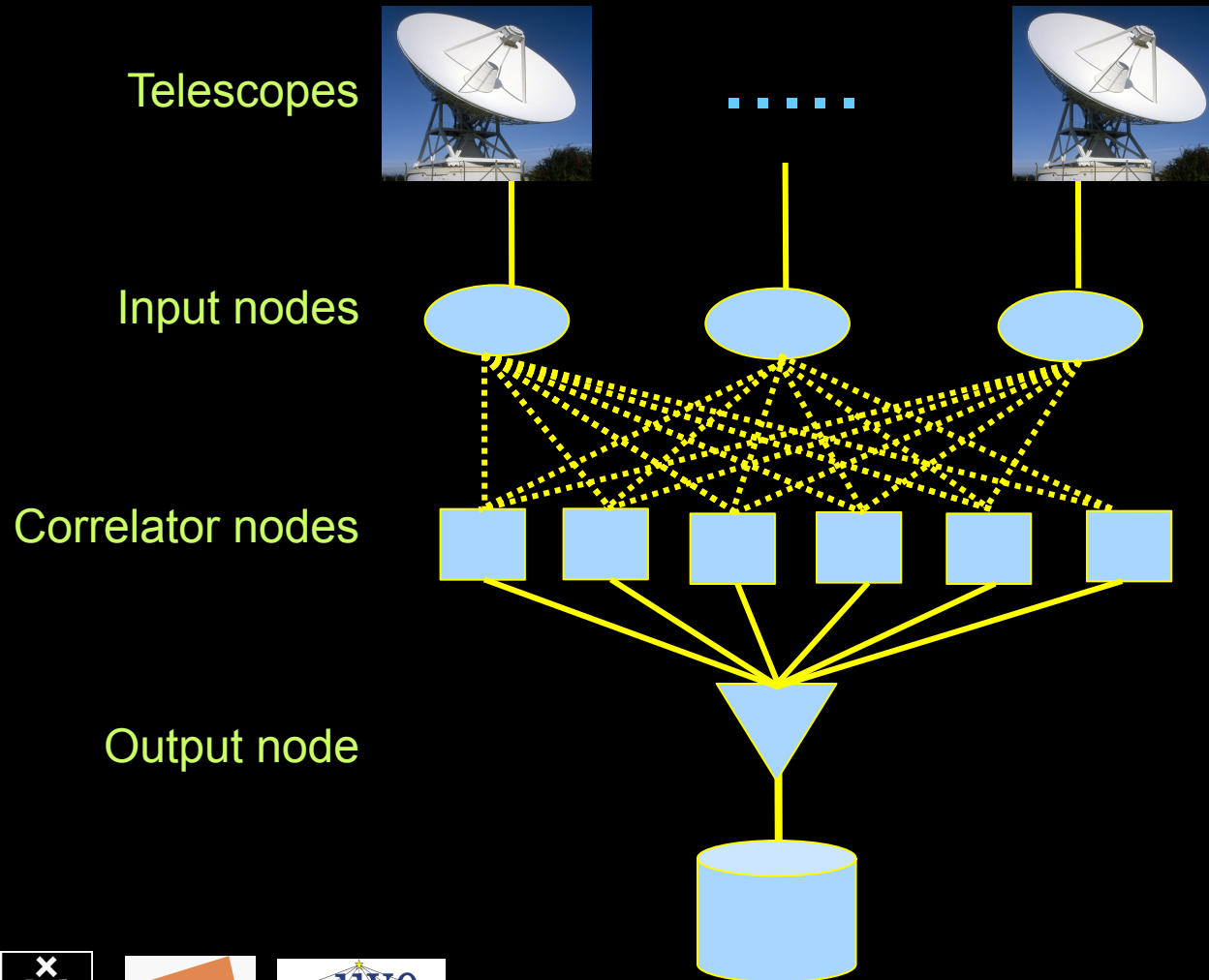

16 Gbit/s - 2 TfloP →
THIS IS A DATA FLOW PROBLEM !!!

Research:

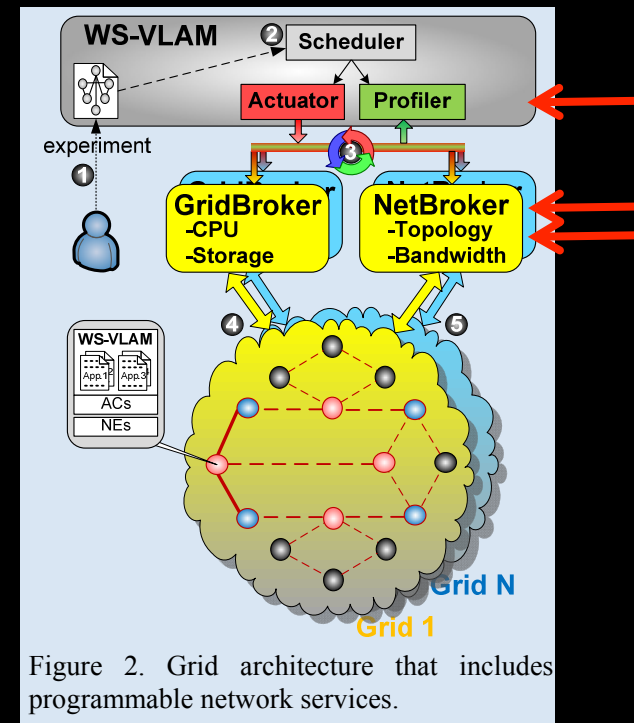
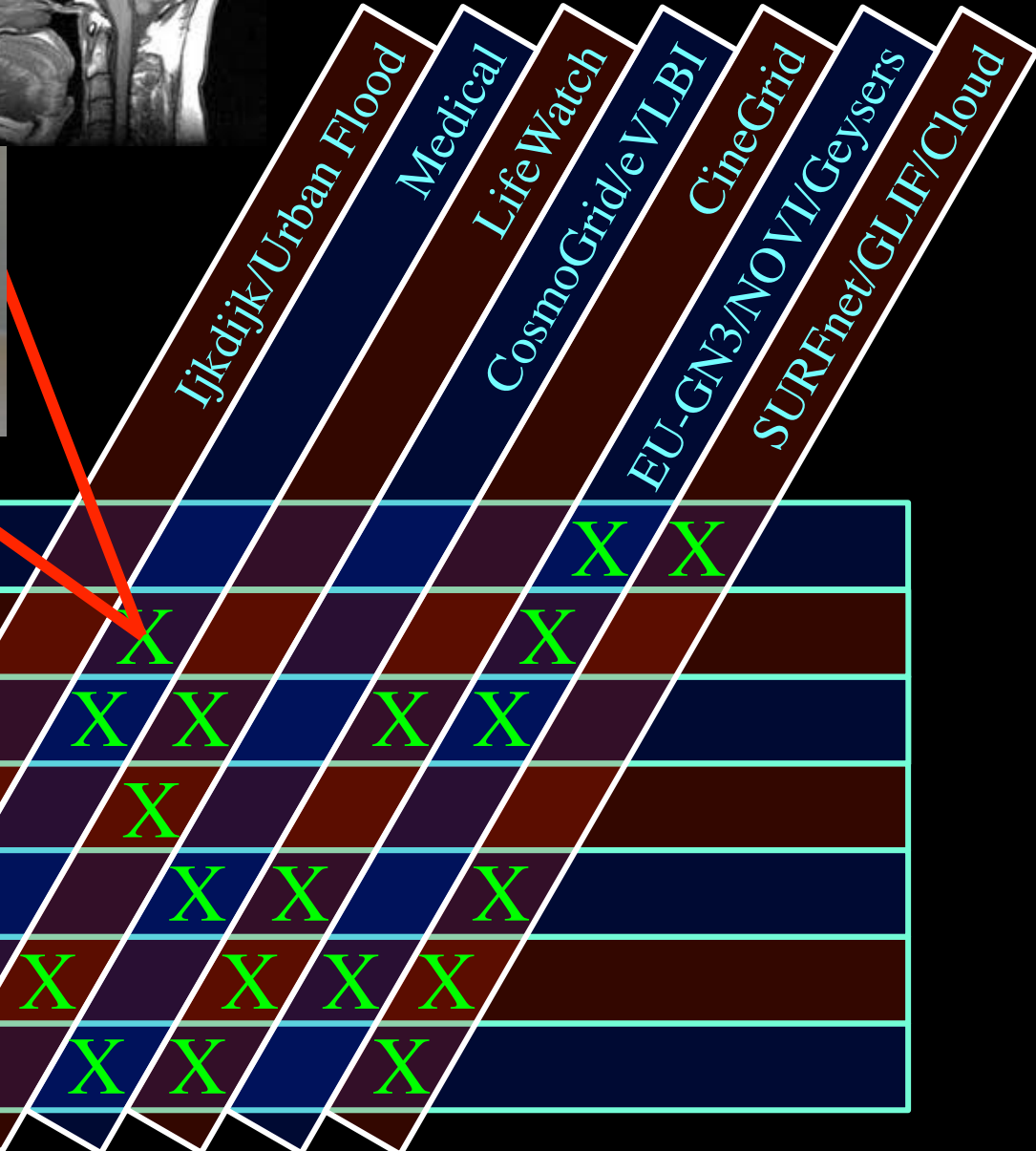
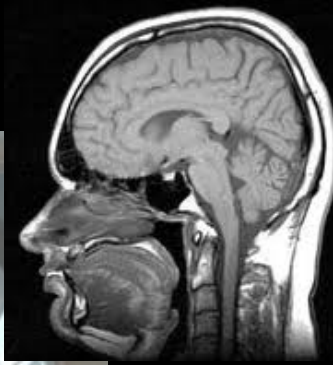

Figure 2. Grid architecture that includes programmable network services.

SNE @ UvA



	Ijkdijk/Urban Flood	Medical	LifeWatch	CosmoGrid/eVLBI	CineGrid	EU-GN3/NOVI/Geysers	SURFnet/GLIF/Cloud
Green-IT						X	X
Privacy/Trust		X				X	
Authorization/policy		X	X		X	X	
Programmable networks	X		X				
40-100Gig/TCP/WF/QoS	X		X	X		X	
Topology/Architecture		X		X	X	X	
Optical Photonic		X	X		X		

Virtual Lab for Neurosciences: Resources

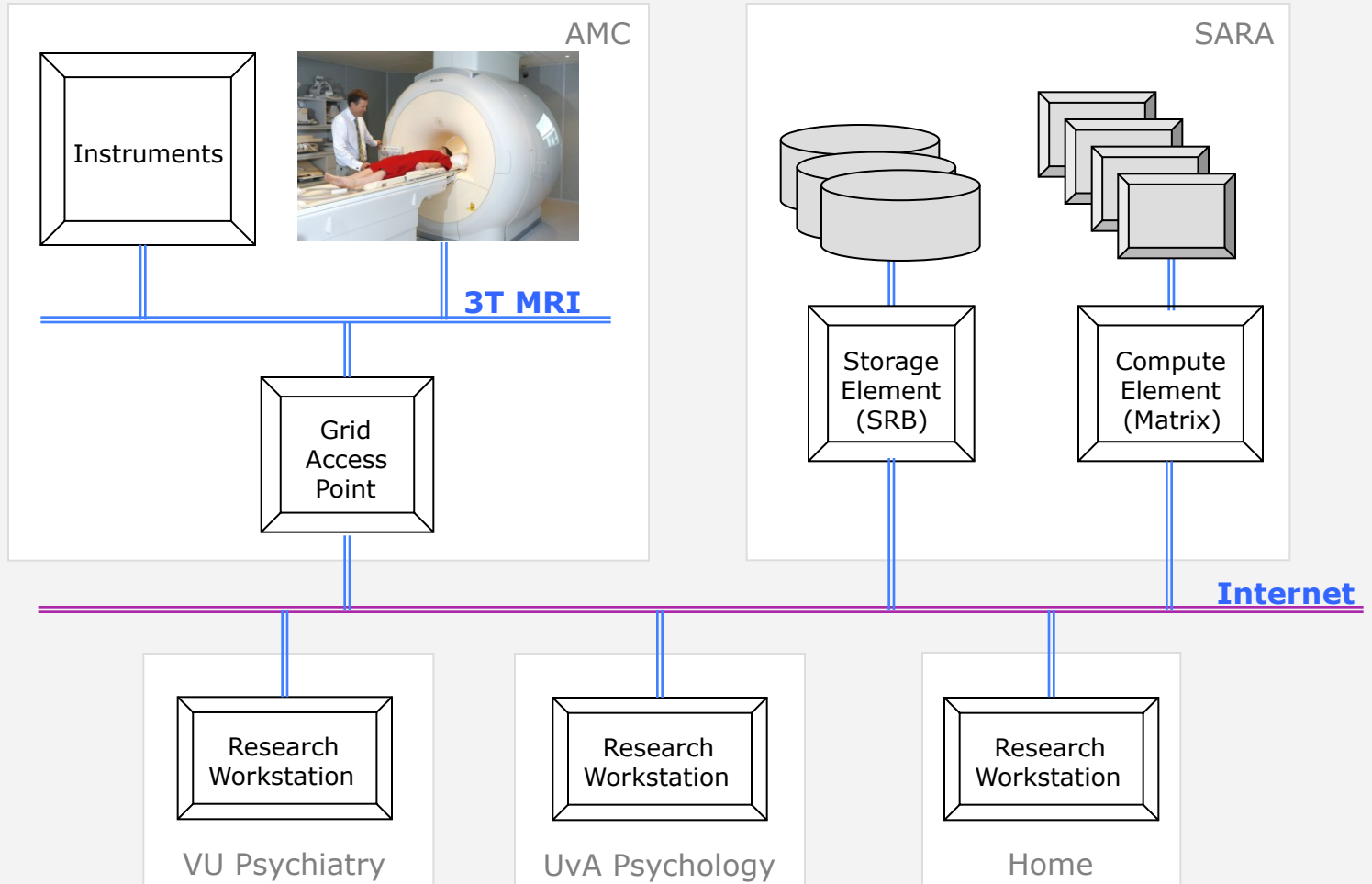

Anonimiteit of her-identificeerbaarheid

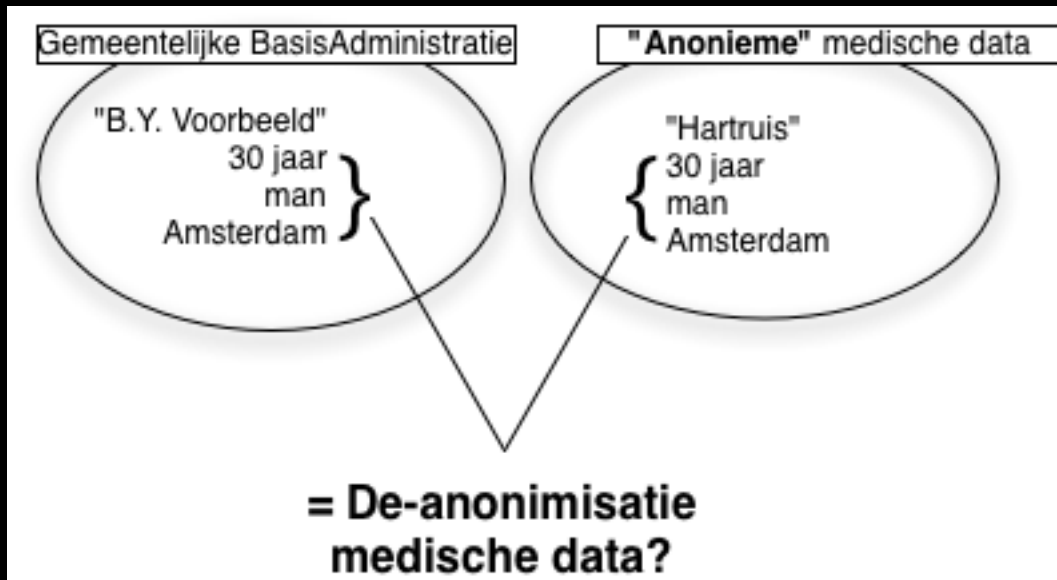

1. Empirische analyse van GBA
2. Kansrekening, bijv. kans op niet-uniciteit:

$$1 - \left(\frac{n-1}{n}\right)^{k-1}$$

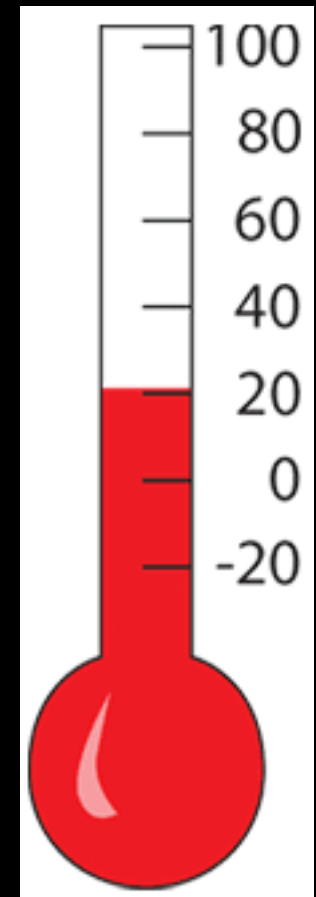

Privacy
thermometer!

Where when will it happen?

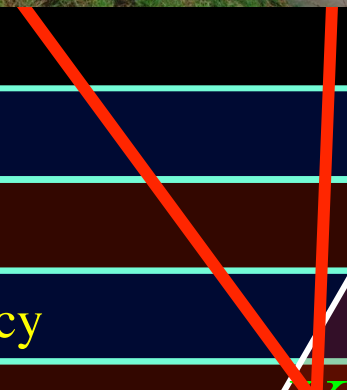

Green-IT					X	X
Privacy/Trust		X			X	
Authorization/policy		X	X		X	X
Programmable networks	X		X			
40-100Gig/TCP/WF/QoS	X		X	X		X
Topology/Architecture		X		X	X	X
Optical Photonic		X	X		X	



IJKDIJK

Sensors: 15000km* 800 bps/m ->12 Gbit/s to cover all Dutch dikes

Sensor grid: instrument the dikes

First controlled breach occurred on sept 27th '08:



Many Pflops/s

Many small flows -> 12 Gb/s

User Programmable Virtualized Networks.

The network is virtualized as a collection of resources
 UPVNs enable network resources to be programmed
 as part of the application

Mathematica interacts with virtualized networks using
 UPVNs and optimize network + computation

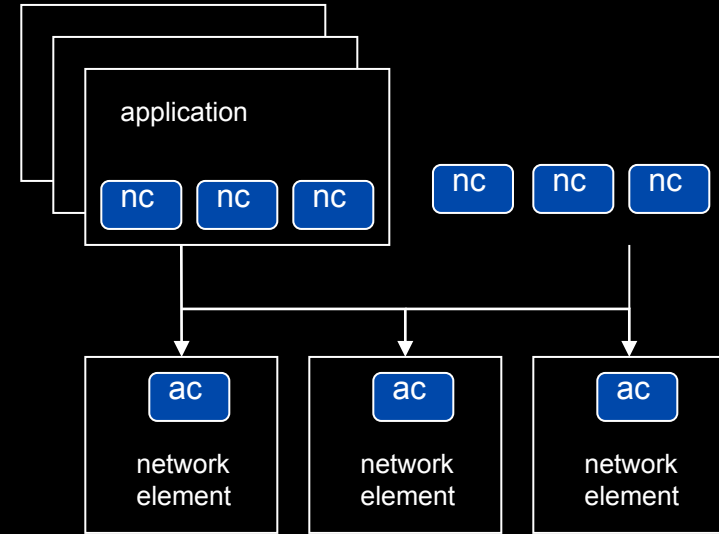

Eigenvalues $\left[\begin{pmatrix} -1 & 0 & 2 \\ 2 & 9 & 2 \\ 3 & 1 & 4 \end{pmatrix}\right]$ {9.484782381, 4.488378326, -1.973160708}	$\sum_{\beta=1}^{30} \frac{1}{\beta^2}$ 1.612150118
Plot [Sin[13 x] + Sin[18 x], {x, 0, 2}]	BesselJ [1, 3 + n] 0.4326156394 - 0.4295057869 n
	Simplify [1 + 5 x + 10 x^2 + 10 x^3 + 5 x^4 + x^5] (1 + x)^5
mydata = {{0.444539, 0.908491}, {1.4486, 1.84577}, {1.8734, 1.84577}, ...}	Fit [mydata, {1, x, x^2}, x] 0.2617148495 + 1.007 x - 0.0034235343 x^2

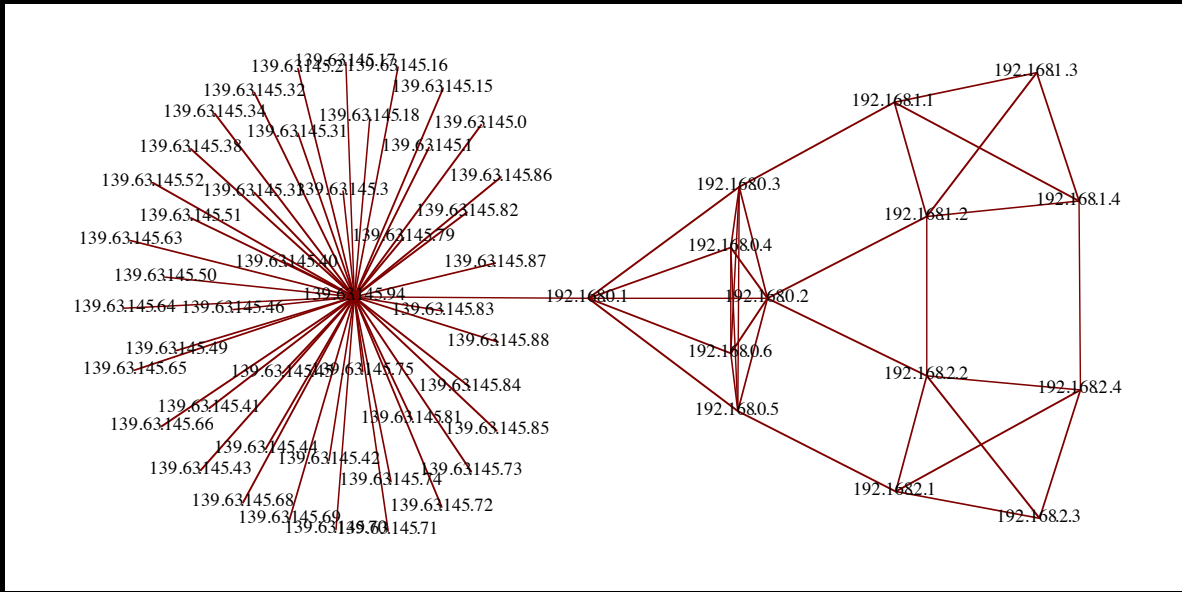

ref: Robert J. Meijer, Rudolf J. Strijkers, Leon Gommans, Cees de Laat, User Programmable Virtualized Networks, accepted for publication to the IEEE e-Science 2006 conference Amsterdam.

TouchTable Demonstration @ SC08



SNE @ UvA



Jkdijk/Urban Flood

Medical

LifeWatch

CosmoGrid/eVLBI

CineGrid

EU-GN3/NOVI/Geysers

SURFnet/GLIF/Cloud

Green-IT

Privacy/Trust

Authorization/policy

Programmable networks

40-100Gig/TCP/WF/QoS

Topology/Architecture

Optical Photonic

X X

X

X

X X

X X

X

X

X

X X

X

X

X X

X X

X

X

X

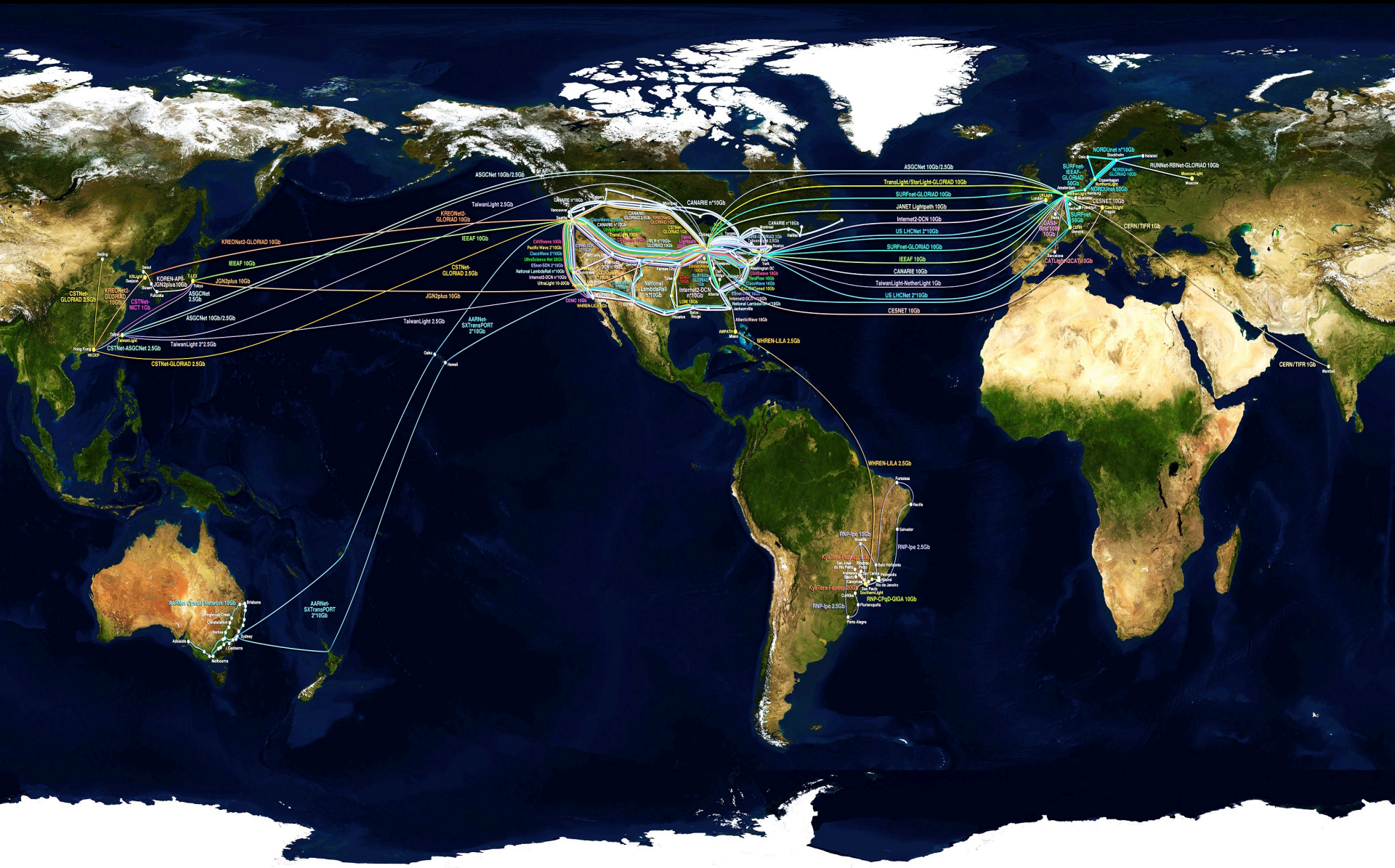

GLIF Map 2008: Global Lambda Integrated Facility Visualization by Robert Patterson, NCSA, University of Illinois at Urbana-Champaign Data Compilation by Maxine D. Brown, University of Illinois at Chicago Earth Texture, visibleearth.nasa.gov

www.glif.is 



GLIF 2008

**Visualization courtesy of Bob Patterson, NCSA
Data collection by Maxine Brown.**

LinkedIn voor infrastructuur



- From semantic Web / Resource Description Framework.
- The RDF uses XML as an interchange syntax.
- Data is described by triplets (Friend of a Friend):

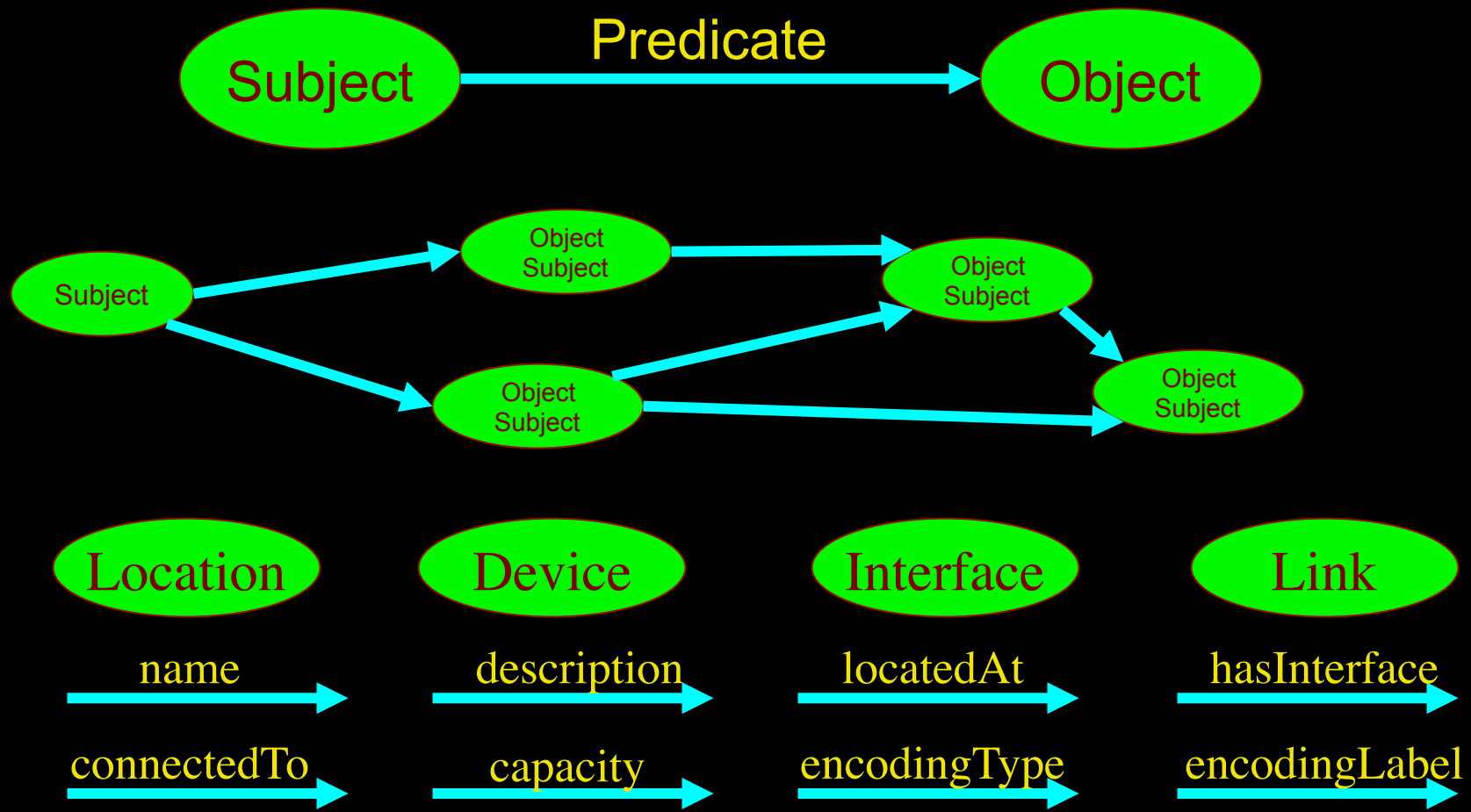

Multi-layer Network PathFinding

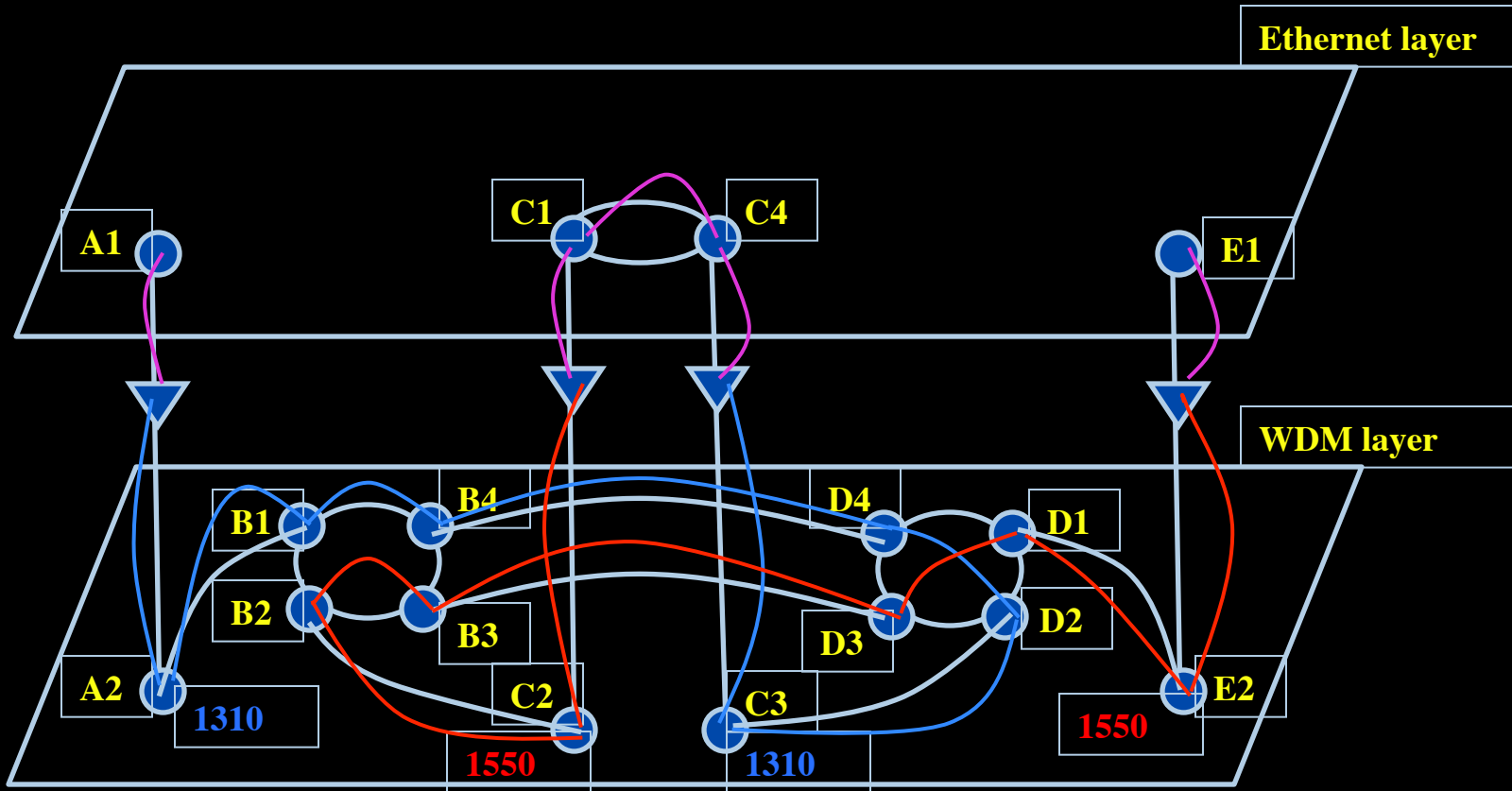

Path between interfaces A1 and E1:

A1-A2-B1-B4-D4-D2-C3-C4-C1-C2-B2-B3-D3-D1-E2-E1

Scaling: Combinatorial problem

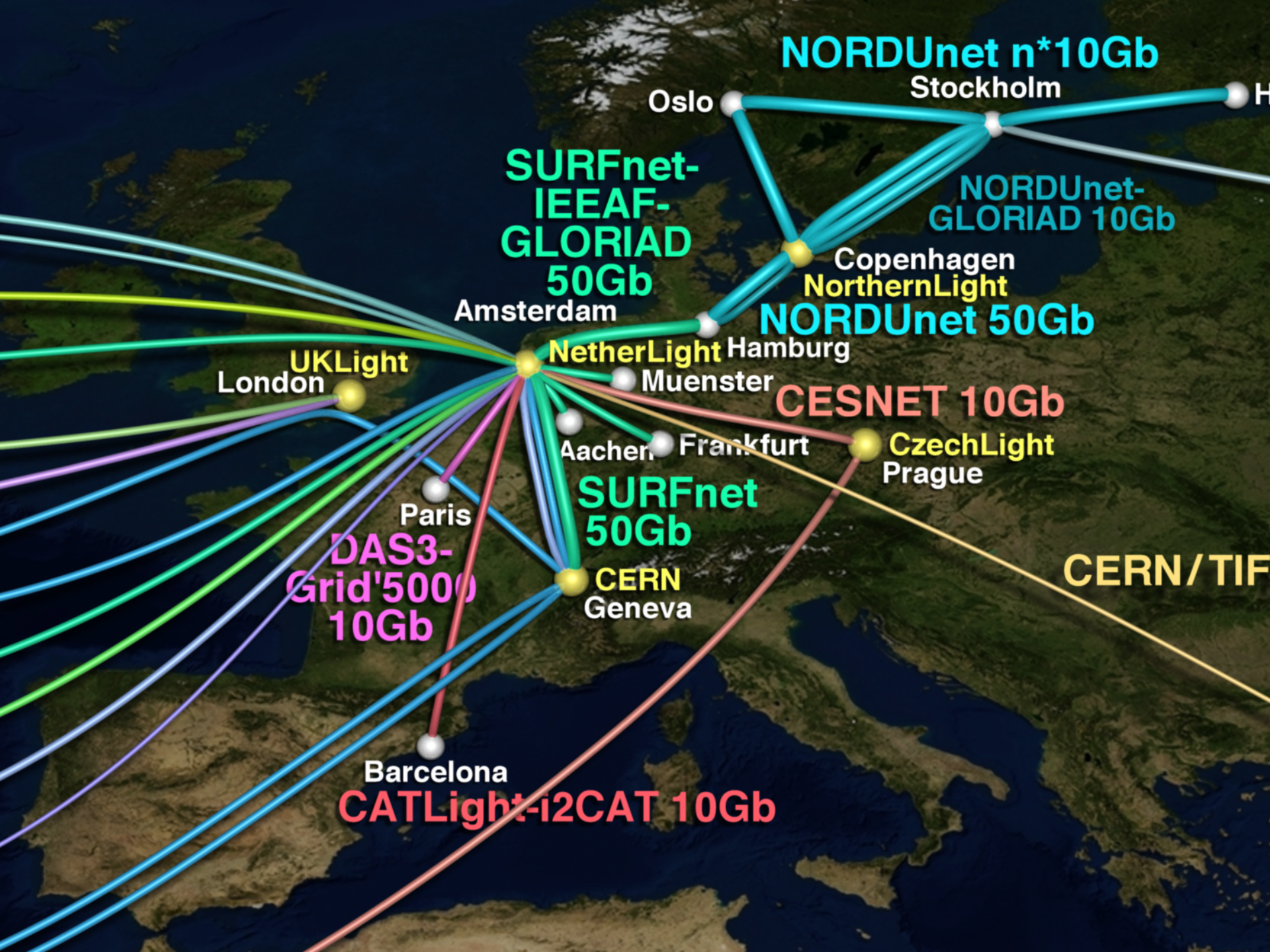

NORDUnet n*10Gb

Oslo

Stockholm

**SURFnet-
IEEAF-
GLORIAD
50Gb**

**NORDUnet-
GLORIAD 10Gb**

Copenhagen

Amsterdam

NORDUnet 50Gb

NetherLight

Hamburg

UKLight

London

NetherLight

Muenster

CESNET 10Gb

Aachen

Frankfurt

CzechLight

Prague

**SURFnet
50Gb**

Paris

**DAS3-
Grid'5000
10Gb**

CERN

Geneva

CERN/TIF

Barcelona

CATLight-i2CAT 10Gb

VIZUALIZATION

DATACENTER

DataExploration

RemoteControl

Management

Backup

TV



Gaming

Mining

Web2.0



Media

Medical

Visualisation

CineGrid

Conference

Security



NetherLight

Meta

Workflow

Clouds



Distributed

EventProcessing

Simulations

GRID&CLOUD

StreamProcessing

SUPERCOMUTTER

Predictions

Barcelona CATLight-i2CAT 10Gb

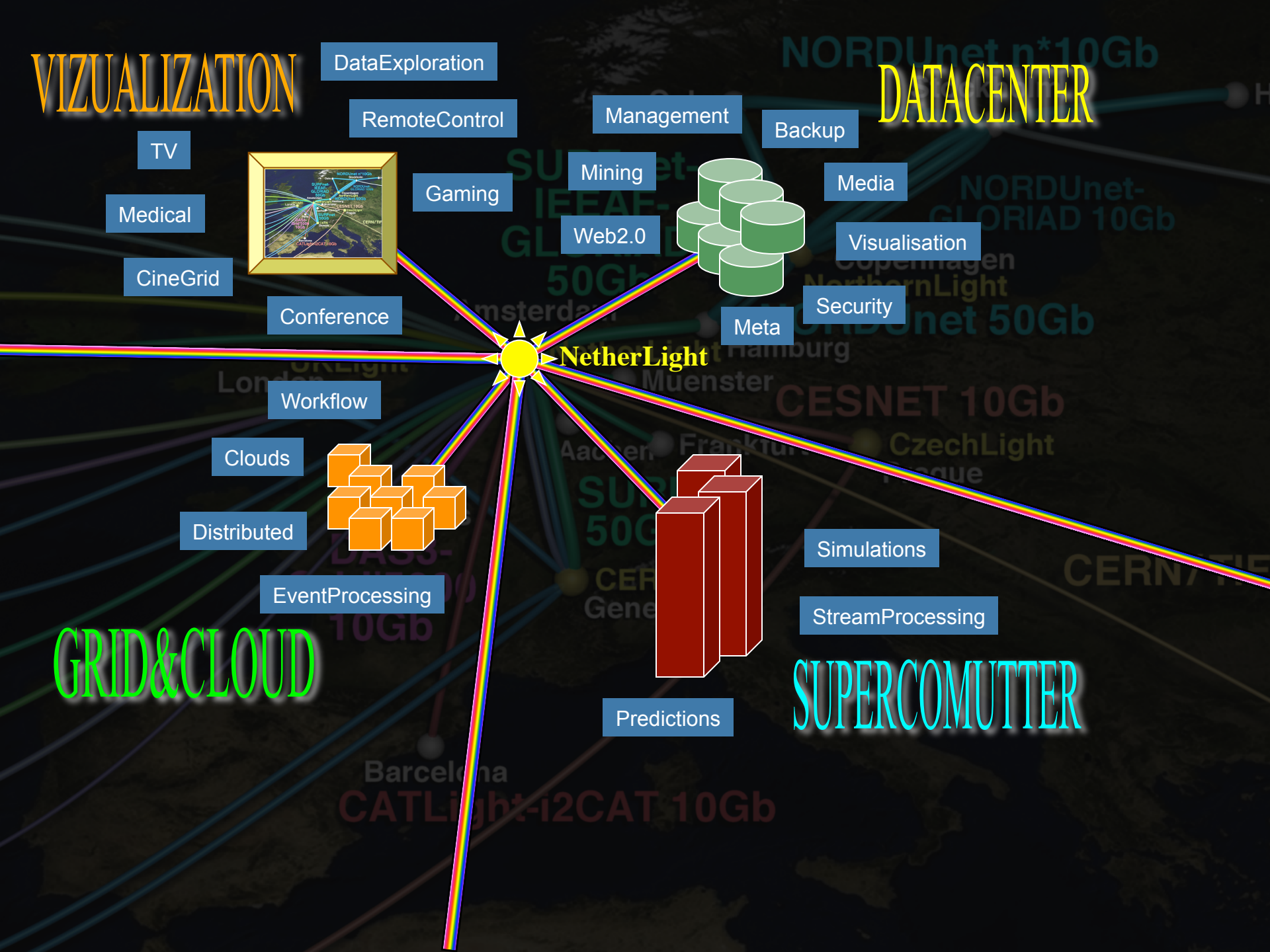

RDF describing Infrastructure

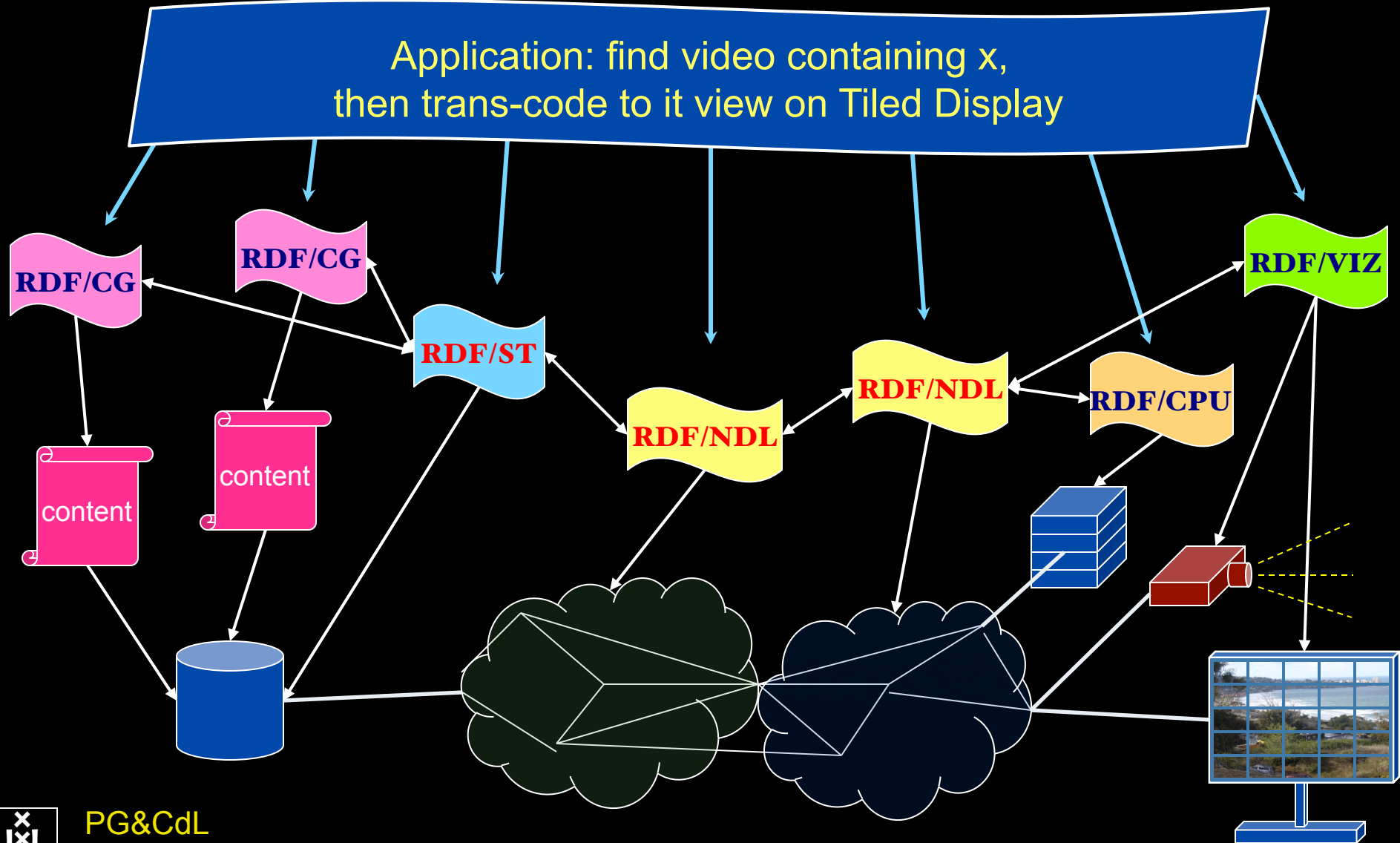

Applications and Networks become aware of each other!

CineGrid is an initiative to facilitate the exchange, storage and display of high-quality digital media.

The CineGrid Description Language (CDL) describes CineGrid resources. Streaming, display and storage components are organized in a hierarchical way. CDL has bindings to the NDL ontology that enables descriptions of network components and their interconnections. With CDL we can reason on the CineGrid infrastructure and its services.

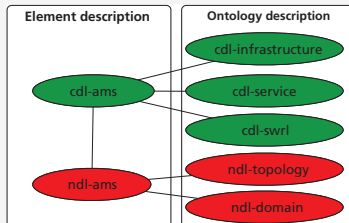

SQWRL is used to query the Ontology.

Which CineGrid nodes are directly connected?



```

cdl:hasElements(?node1, ?host1) ^
ndl-topo:hasInterface(?host1, ?if1) ^ ndl-
topo:connectedTo(?if1, ?if2) ^
ndl-topo:hasInterface(?host2, ?if2) ^
cdl:hasElements(?node2, ?host2) ->
sqwrl:select(?node1, ?node2)
    
```

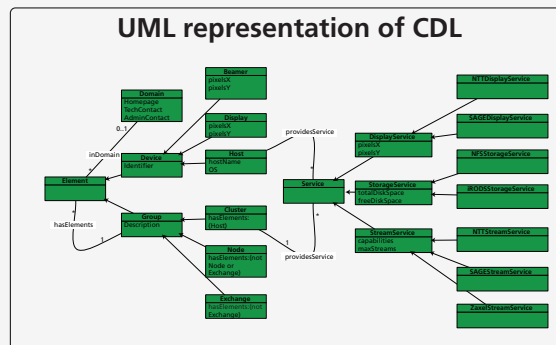
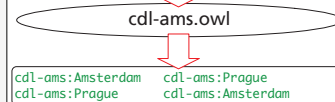

CDL links to NDL using the owl:SameAs property. CDL defines the services, NDL the network interfaces and links. The combination of the two ontologies identifies the host pairs that support matching services via existing network connections.

```

<cdl:hasElements>
<cdl:has rdf:ID="cgldoo">
<cdl:hasDomain rdf:resource="http://www.w3.org/2002/07/owl#cgldoo">
<cdl:hasRange rdf:resource="http://www.w3.org/2002/07/owl#cgldoo">
<cdl:hasProperty rdf:ID="cgldoo:hasInterface">
<cdl:hasProperty rdf:ID="cgldoo:connectedTo">
<cdl:hasProperty rdf:ID="cgldoo:hasStorageService">
<cdl:hasProperty rdf:ID="cgldoo:hasStreamingService">
</cdl:hasElements>
    
```

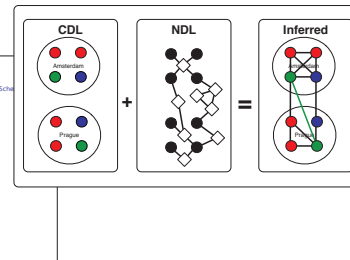

Virtualisatie van infrastructuur & QoS

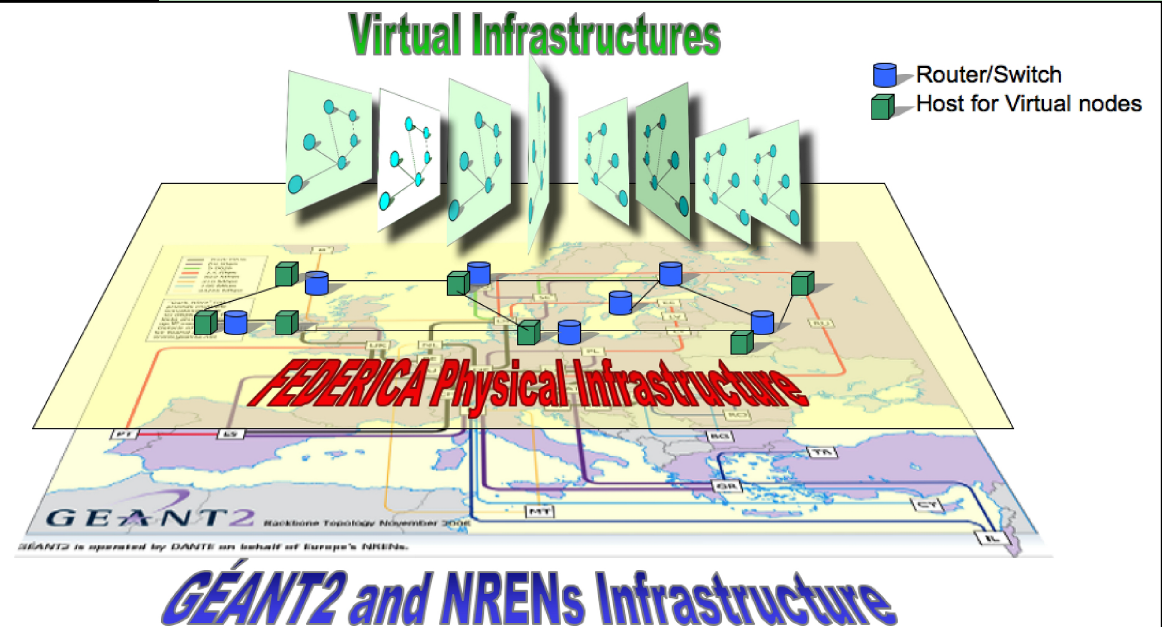
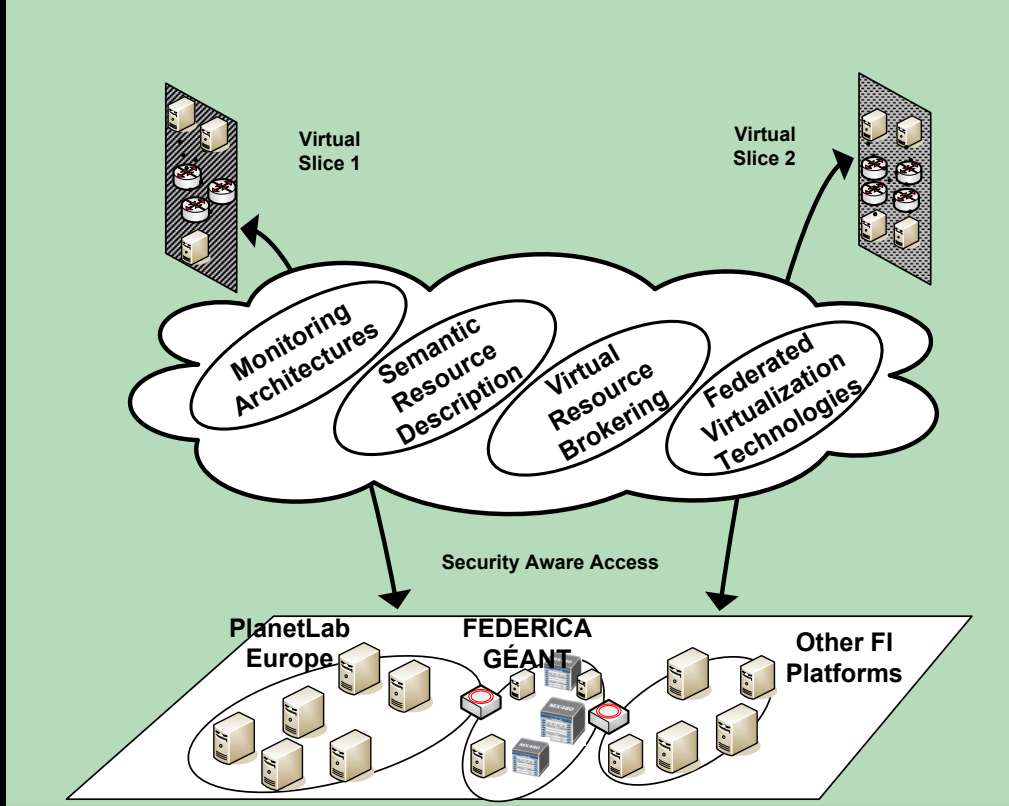
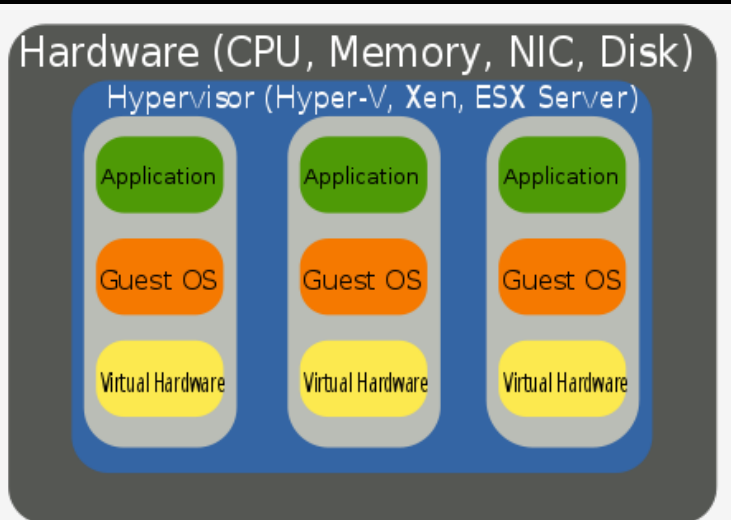

Current view

Distinct Infrastructures / Distinct User Experiences

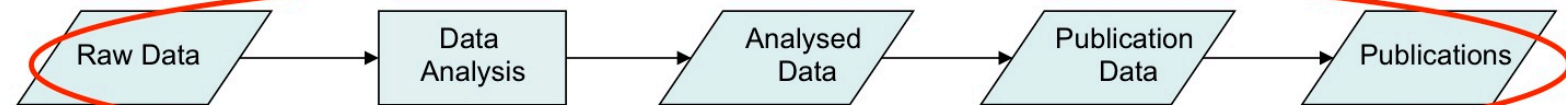

Facility 1

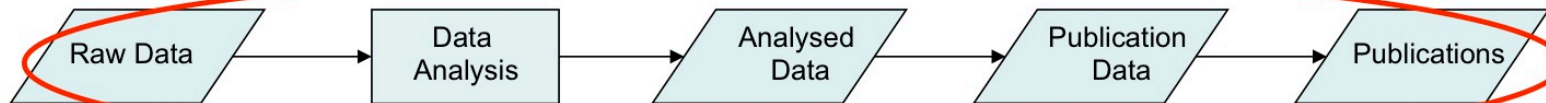

Facility 2

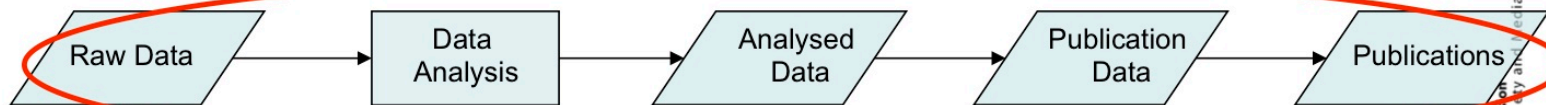

Facility 3

Future view (e-Infrastructure enabled)

Common Infrastructure / Common User Experience

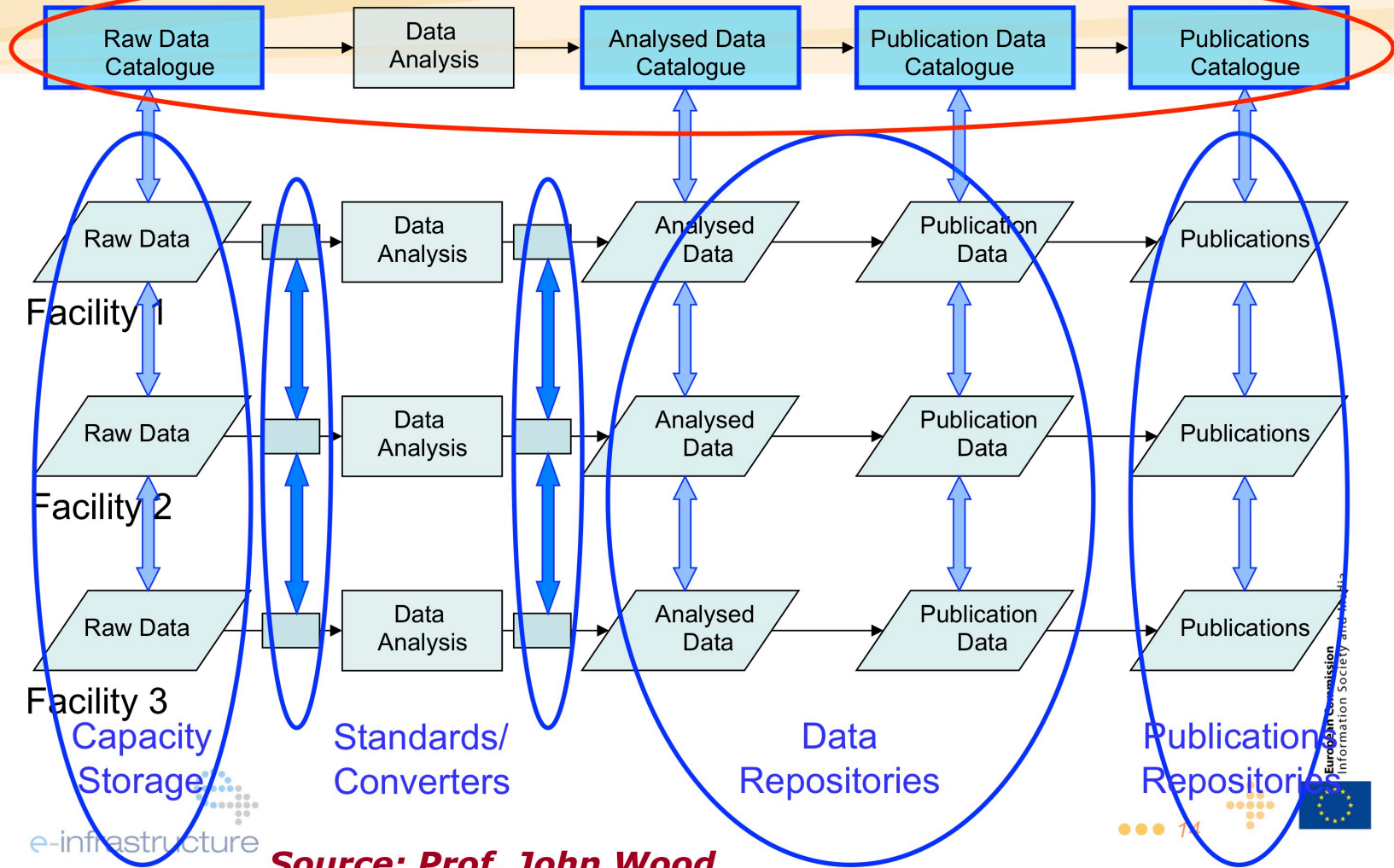

Source: Prof. John Wood

SNE @ UvA



Ijkdijk/Urban Flood
Medical
LifeWatch
CosmoGrid/eVLBI
CineGrid
EU-GN3/NOVI/Geysers
SURFnet/GLIF/Cloud

Green-IT

Privacy/Trust

Authorization/policy

Programmable networks

40-100Gig/TCP/WF/QoS

Topology/Architecture

Optical Photonic

						X	X
		X				X	
	X	X		X	X		
X		X					
X			X	X		X	
	X		X	X	X		
	X	X		X			

Why is more resolution is better?

1. More Resolution Allows Closer Viewing of Larger Image
2. Closer Viewing of Larger Image Increases Viewing Angle
3. Increased Viewing Angle Produces Stronger Emotional Response

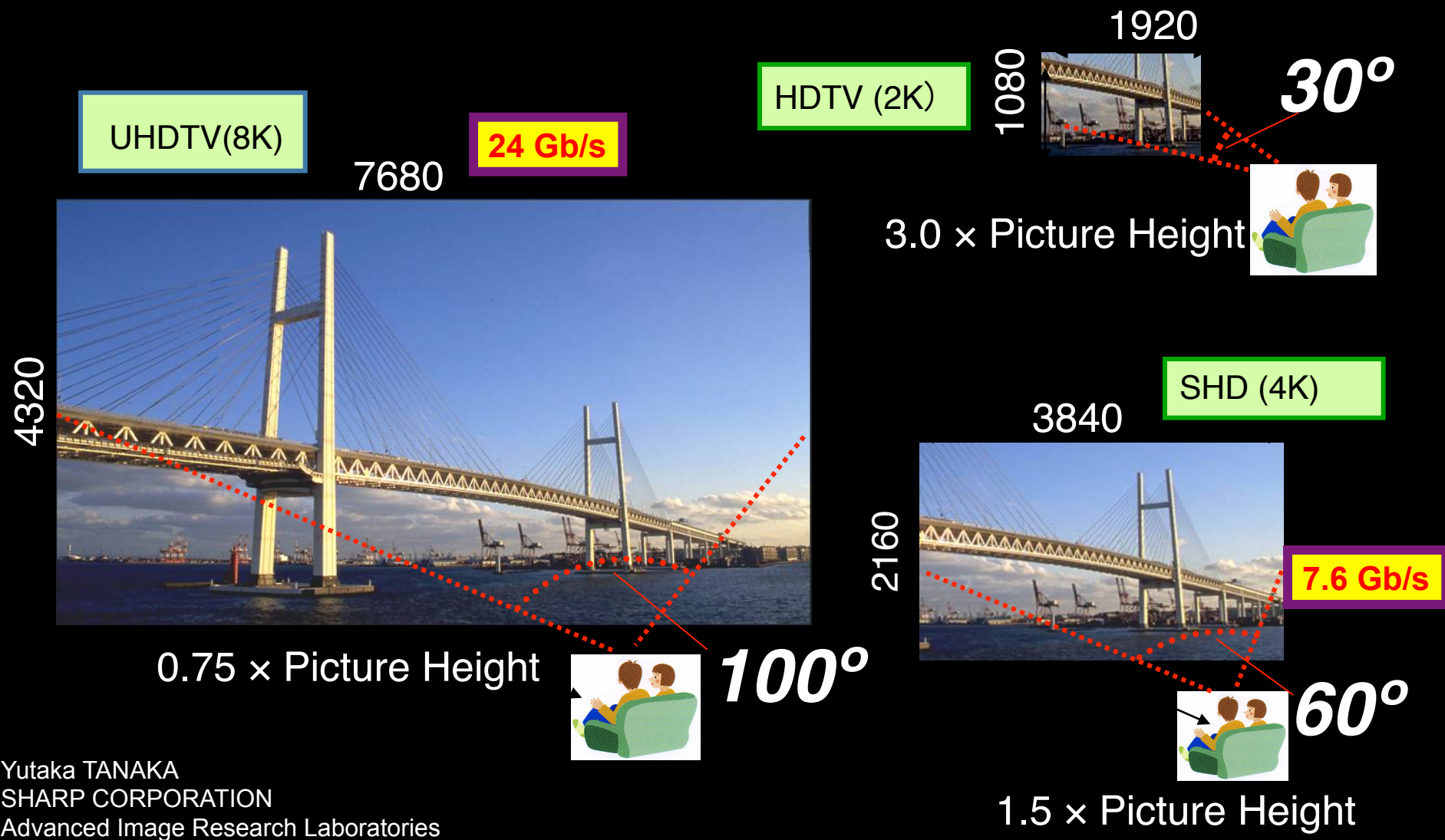



Red End
Robin Noorda & Bethany de Forest



Hey, sit still.



We're almost done. Sshh...



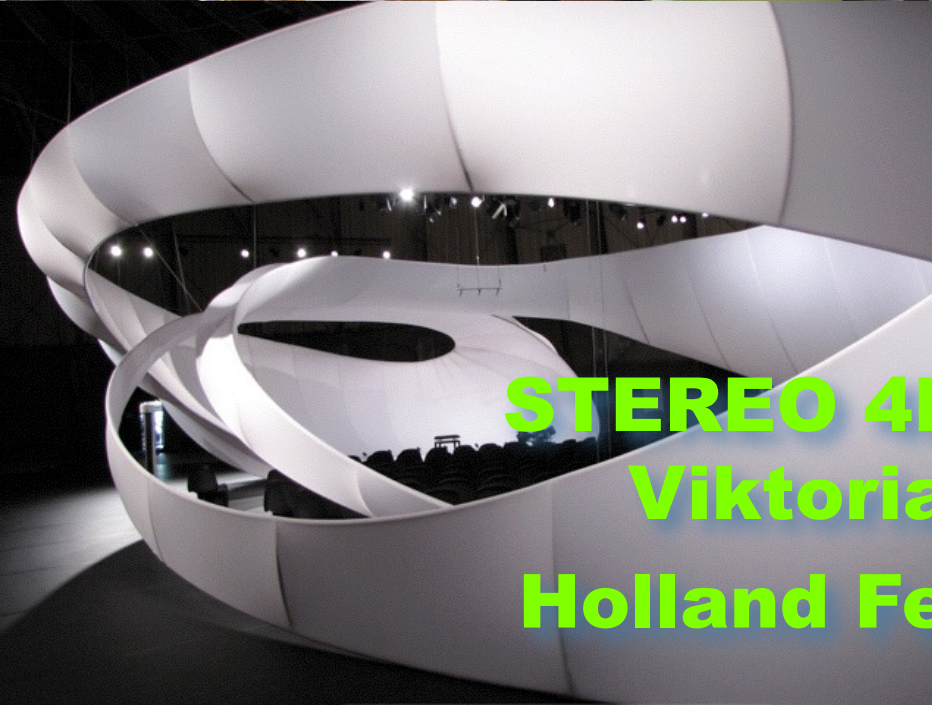

**STEREO 4K Recording
Viktoria Mullova
Holland Festival 2010**

Onderwijs - Master SNE

- Open Source aanpak

☺ Hij luistert
naar ons!



- Gebaseerd op open en non-discriminatory standaarden
- Privacy en Security
- Digitale beveiliging & forensics
- Internet infrastructuur
- Opleiding nauw verweven met de onderzoeksgroep!

DNSsec 

Secured by DNSSEC

Domain name:

www.os3.nl

is secured by DNSSEC.

Your computer is also secured by DNSSEC for this particular domain, so you are secured against domain name spoofing.



Trace: » Contents and links » InterNetwork

Master Education

SNE is the  University of Amsterdam master education in System and Network Engineering.

We focus on **Open Standards**, **Open Software** and **Open Security**, hence the name **OS3**.

Information

General information and testimonials are available at the

- [Introductory page](#)

More in depth facts can be found on our

- [Master SNE page](#)

Contact

If you want to make a personal appointment to visit our education or to attend a lecture, please contact us via *info* at *os3 dot nl*.

You can visit our [facilities](#) at the Science Faculty of the University of Amsterdam located at the Science Park Amsterdam.

Search

- Home
- ▶ Info

- 2010-2011
- Schedule
- ▼ Courses
 - ES
 - CIA
 - SSN
 - DIA
 - RP1
 - INR
 - CF
 - LIA
 - OT
 - ICP
 - VA
 - RP2
 - Colloquia

- [OS3 Masters Theses](#)
- ▶ Archive

Links

Uitdagingen

- Onderzoeksthema's:
 - Disruptive ontwikkeling infrastructuur
 - Slimme infrastructuur
 - Groene ICT & energie, smart – grids
 - Virtualisatie en deterministisch gedrag
 - Autorisatie & vertrouwen (trust)
 - Veiligheid en privacy in een Internet wereld



- Toepassingen

- LifeWatch, IJkdijk, Medische beeldverwerking
- Research Netwerken, Data intensieve app's (LHC)
- Digitale Cinema, creatieve sector

Dankwoord

Many thanks to my research Group!

(co-authors since 2001 @ UvA)

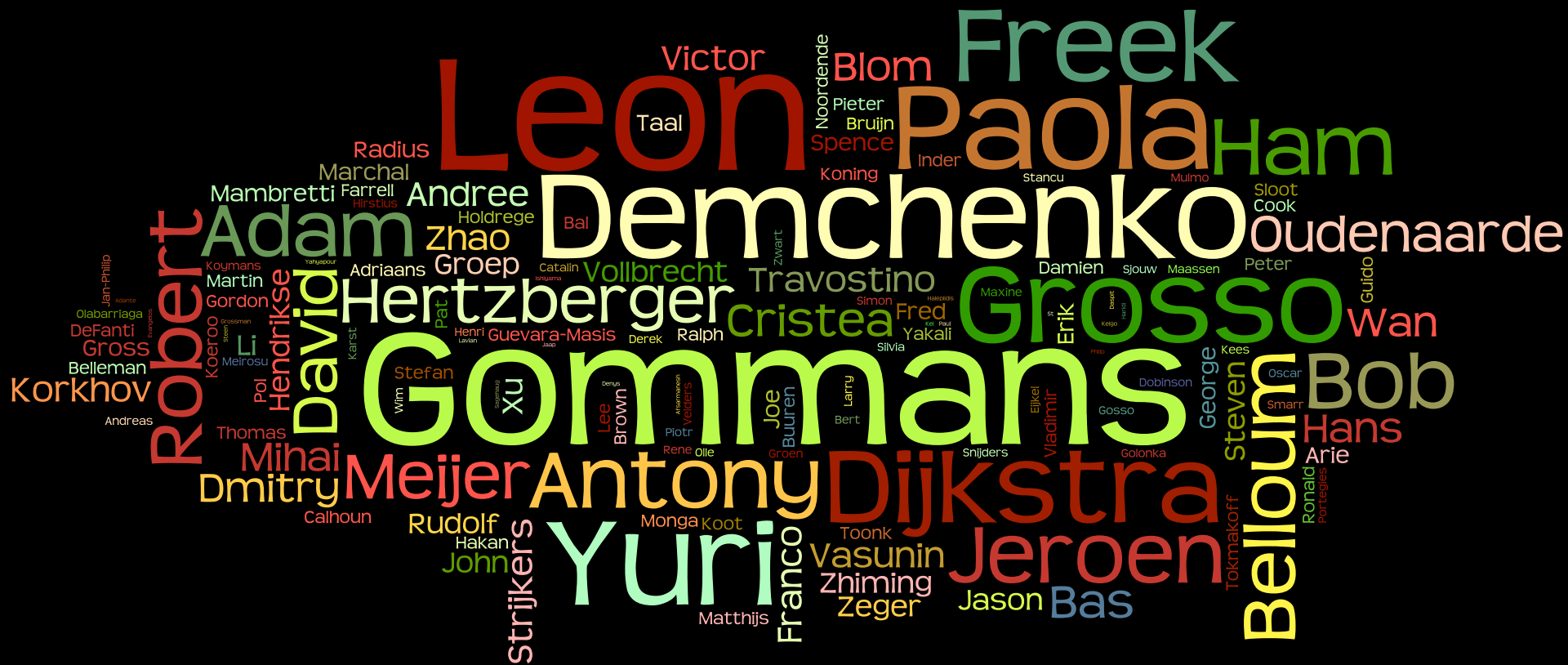

Master OS3!

(master sinds 2003 @ UvA)

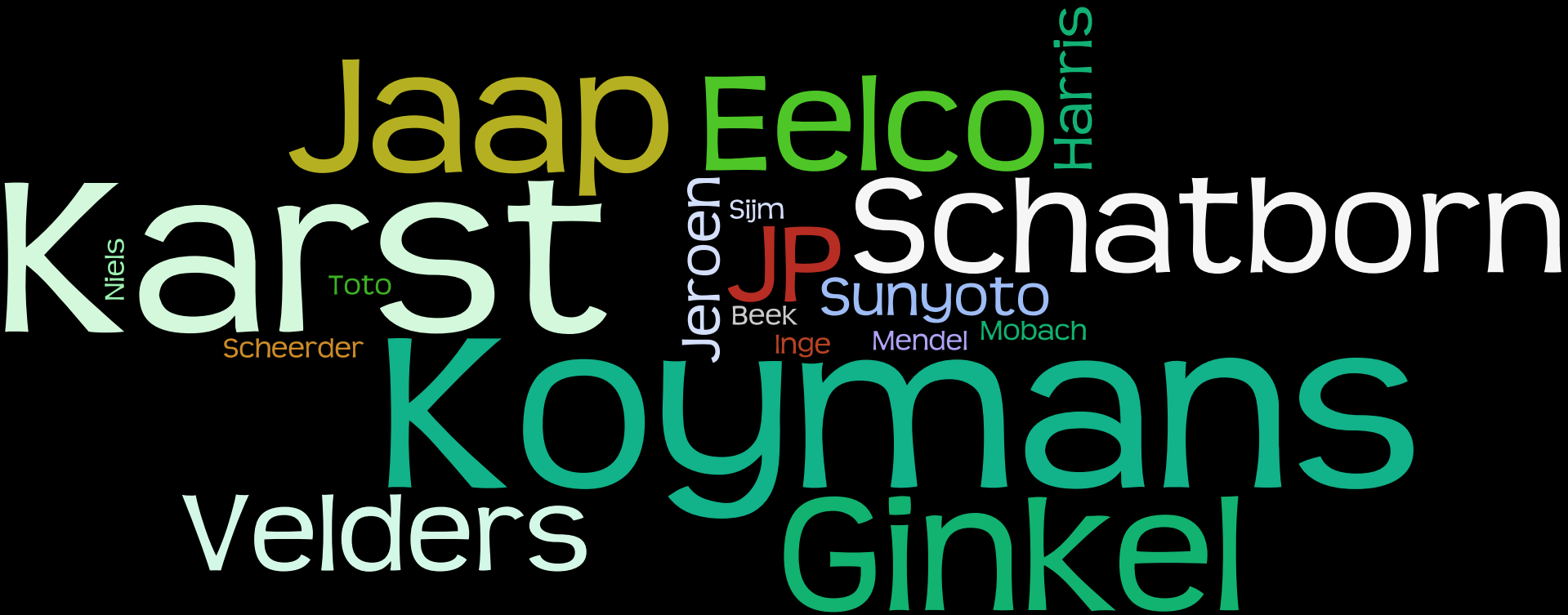

A word cloud of names on a black background. The names are arranged in various sizes and orientations. The largest names are 'Karst', 'Koymans', and 'Schatborn'. Other prominent names include 'Jaap', 'Eelco', 'Ginkel', and 'Velders'. Smaller names include 'Niels', 'Toto', 'Scheerder', 'Jeroen', 'Sijm', 'JP', 'Beek', 'Inge', 'Mendel', 'Mobach', 'Sunyoto', and 'Harris'.

Niels
Jaap
Eelco
Harris
Karst
Toto
Scheerder
Jeroen
Sijm
JP
Beek
Inge
Mendel
Mobach
Sunyoto
Koymans
Velders
Ginkel
Schatborn



EU

SARA

SURF-ESRC

Pieken-in-de-Delta

SURFnet

FES UVVA

NWO

NWO-RCF

Tot slot ...

De winter komt eraan...





Bezuinigingen in hoger onderwijs op een rij

19-01-2011 13:33 | gewijzigd 19-01-2011 14:57



DEN HAAG (ANP) – In het regeerakkoord is een aantal maatregelen aangekondigd die komende jaren te bezuinigen op het onderwijs. Bij de oppositie in de Tweede Kamer betrokken organisaties zorgen met name de bezuinigingen op het passend onderwijs en het hoger onderwijs voor veel onrust. Duizenden studenten worden vrijdag in Den Haag verwacht voor een protestbijeenkomst.

Het kabinet wijst er steeds op dat bezuinigingen nodig zijn om de overheidsfinanciën op orde te houden. Ze maken volgens het kabinet bovendien financiële ruimte vrij om het onderwijs te verbeteren. In 2015 gaan bezuinigingen en investeringen in het hoger onderwijs volgens het kabinet vrijwel gelijk zijn.

Een overzicht van de belangrijkste bezuinigingen in het hoger onderwijs:

- sociaal leenstelsel in masterfase: opbrengst in 2015 20 miljoen en jaren daarna 110 miljoen
- verhoging collegegeld voor langstudeerders met 3000 euro: opbrengst vanaf 2015 140 miljoen
- 'boete' voor instellingen per langstudeerder: opbrengst vanaf 2015 140 miljoen
- bezuinigingen door ander studeergedrag studenten: opbrengst vanaf 2015 90 miljoen
- afschaffing OV-jaarkaart voor langstudeerders: opbrengst 30 miljoen vanaf 2015
- efficiency bij onderzoek en innovatie: opbrengst vanaf 2015 90 miljoen

Bezuinig

19-01-2011 13

**DEN HAAG (A
komende jaren
betrokken org
het hoger ond
verwacht voo**

Het kabinet wij
Ze maken volge
2015 gaan bez

Een overzicht v

-sociaal leenste

-verhoging colle

-'boete' voor in

-bezuinigingen

-afschaffing OV

-efficiency bij o

Bezuinigingen op hoger onderwijs zijn funest voor de kenniseconomie

NRC 18 januari 2011: Opinie

Anton Franken en Bas Ibelings

De studenten protesteren vrijdag tegen kortingen op het onderwijs. Ook andere maatregelen maken Nederland onaantrekkelijk, betogen Anton Franken en Bas Ibelings.

Het kabinet wil vanaf 2012 enkele honderden miljoenen euro's bezuinigen op hoger onderwijs. Hierdoor verdwijnen duizenden arbeidsplaatsen aan universiteiten en hogescholen. Dat betekent een enorm verlies van kwaliteit in het wetenschappelijk onderwijs – dat bovendien minder studenten zal trekken, onder meer door de langstudeerdersmaatregel. De kracht van universiteiten als motor voor de kenniseconomie zal alleen daardoor al afnemen.

Daarbij blijft het niet. Het wegvallen van de gelden uit het Fonds Economische Structuurversterking (FES) betekent een nog verdere verschraling. Uit het FES is de afgelopen vijftien jaar ruim 3 miljard euro – de laatste jaren min **maals 500 miljoen euro per jaar** – geïnvesteerd in kennis en innovatie. De FES-gelden, een pot met aardgasbaten, zullen opgaan in de 'algemene middelen', lees: de s t a a t s s c h u l d .



Deze bezuinigingen zijn funest
voor de kenniseconomie!

Ik heb gezegd! ...



En dan nog dit:

Ik verzoek U vriendelijk geen traditionele felicitatie rij te vormen bij de receptie maar meteen naar de drankjes en hapjes te grijpen!

Ik kom wel naar U toe.

